

 **FERRAL®**

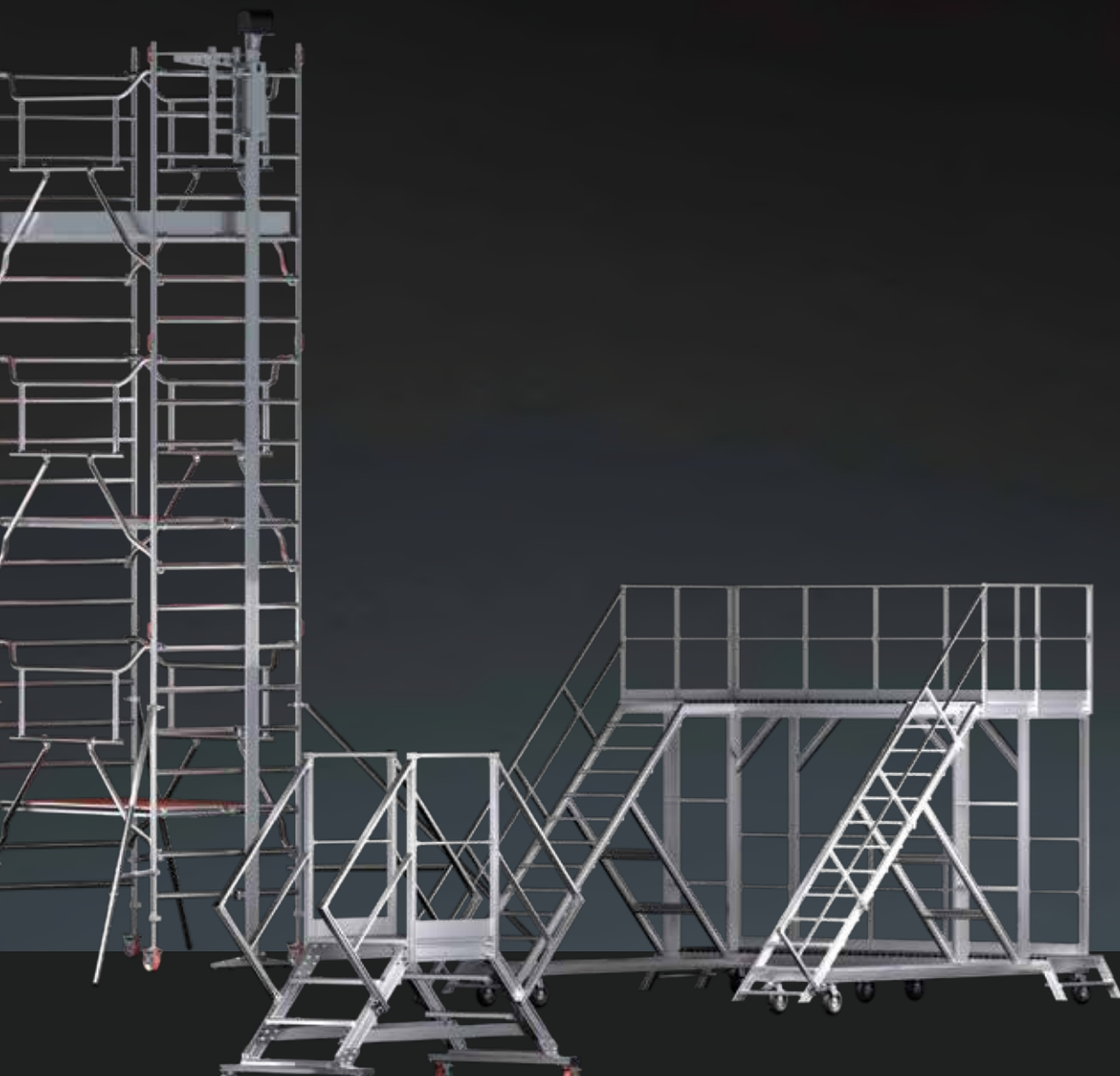

2026



FERRAL®

FERRAL

EMPRESA | COMPANY | SOCIÉTÉ | EMPRESA



1981-2026

PT | Fundada em 1981, a Ferral - José Luís & Ca. Lda. é a empresa Portuguesa líder no fabrico e distribuição de escadas, escadotes e andaimes em alumínio e fibra de vidro. Mais de quatro décadas em constante evolução, a empresa tornou-se uma referência de inovação e competitividade na sua área de atividade, contando hoje com 6 modernas linhas de produção que abrangem uma área coberta de 7.500 m².

A localização da unidade produtiva, 40 Km a Sul do Porto de Leixões (Porto), foi desde o início da sua atividade uma vantagem competitiva no mercado de exportação, permitindo à Ferral uma diversificação da sua carteira de clientes pelos vários pontos do globo, hoje representada em 40 países e 4 continentes.

Na Ferral trabalhamos interdisciplinarmente para garantir que os produtos que desenvolvemos correspondem às necessidades do mercado, do ponto de vista de função, facilidade de utilização e segurança. A Ferral dispõe de laboratório de testes para acompanhamento do processo de desenvolvimento de produto, garantindo o cumprimento das mais exigentes normas de segurança em vigor. É neste laboratório que são realizados testes diários aos artigos produzidos.

A empresa tem implementado um Sistema de Gestão da Qualidade certificado segundo a norma ISO 9001 para todos os seus processos, assim como um Sistema de Gestão Ambiental com certificação ISO 14001.

Oferecer a todos os clientes uma solução de segurança e confiança no mercado continuará a ser a nossa missão. Somos conscientes da responsabilidade do produto que fabricamos.

EN | Founded in 1981, Ferral - José Luís & Ca. Ltd is the leading Portuguese company in the manufacture and distribution of aluminium and fiberglass ladders, stepladders and scaffolding. Constantly evolving for more than four decades, the company has become a benchmark for innovation and competitiveness in its area of activity, counting today with 6 modern production lines which comprise a covered area of 7.500 m².

The location of the production unit, 40 km south of the Port of Leixões (Porto), has been a competitive advantage in the export market since the beginning of its activity, allowing

Ferral to diversify its customer portfolio across multiple parts of the globe, today represented in 40 countries and 4 continents.

At Ferral, we work interdisciplinary to ensure that the products we develop correspond to the needs of the market, from the point of view of function, ease of use and safety. Ferral has a testing laboratory to monitor the product development process, ensuring compliance with the most demanding safety standards. It is in this laboratory that daily tests are carried out on the articles produced.

The company has implemented a certified Quality Management System, according to the ISO 9001 standard for all its processes, as well as an Environmental Management System with ISO 14001 certification.

To offer all customers a solution that is safe and reliable in the market will continue to be our mission. We are aware of the responsibility of the product we manufacture.

FR | Fondée en 1981, Ferral - José Luís & Ca. Ltd est la principale entreprise portugaise dans la fabrication et la distribution d'échelles, d'escabeaux et d'échafaudages en aluminium et fibre de verre. En quatre décennies en constante évolution, l'entreprise est devenue une référence en matière d'innovation et de compétitivité dans son domaine d'activité, comptant aujourd'hui 6 lignes de production modernes couvrant une surface couverte de 7.500 m².

L'emplacement de l'unité de production, au sud du port de Leixões (Porto), reste un avantage concurrentiel sur le marché de l'exportation, permettant à Ferral de diversifier son portefeuille de clients dans les différentes parties du globe, aujourd'hui représenté dans 40 pays et 4 continents.

Chez Ferral, nous travaillons de manière interdisciplinaire pour nous assurer que les produits que nous développons correspondent bien aux besoins du marché, du point de vue de la fonction, de la facilité d'utilisation et de la sécurité. Ferral dispose d'un laboratoire d'essais pour surveiller le processus de développement des produits, garantissant le respect des normes de sécurité les plus exigeantes en vigueur. C'est dans ce laboratoire que des tests quotidiens sont effectués sur les produits.

L'entreprise a mis en place un Système de Management de la Qualité certifié selon la norme ISO 9001 pour l'ensemble de ses processus, ainsi qu'un Système de Management Environnemental certifié ISO 14001.

Offrir à tous les clients une solution sûre et fiable sur le marché continuera d'être notre mission. Nous sommes conscients

de la responsabilité du produit que nous fabriquons.

ES | Fundada en 1981, Ferral - José Luís & Ca. Lda. es la empresa portuguesa líder en fabricación y distribución de escaleras, andamios de aluminio y fibra de vidrio. En constante evolución durante cuatro décadas, la empresa ha logrado convertirse en un claro referente en innovación y competitividad dentro de su área de actividad, con una superficie cubierta superior a los 7.500 m² que alberga 6 modernas líneas de producción.

La ubicación de la unidad productiva, 40 km al sur del Puerto de Leixões (Oporto), ha supuesto una gran ventaja competitiva para el mercado de exportación, desde el inicio de su actividad, permitiendo a Ferral diversificar su cartera de clientes en las distintas partes del globo, abarcando hoy más de 40 países y 4 de los 5 continentes.

En Ferral trabajamos de forma interdisciplinar para que los productos que desarrollamos logren satisfacer las necesidades de nuestros clientes, desde el punto de vista funcional, facilidad de uso y la seguridad. Ferral dispone de un laboratorio de ensayos para garantizar el proceso de desarrollo de producto, asegurando el cumplimiento de las más exigentes normas de seguridad vigentes. Es en este laboratorio, se realizan pruebas diarias a los artículos producidos.

La empresa tiene implantado un Sistema de Gestión de Calidad certificado según la norma ISO 9001 para todos sus procesos, así como un Sistema de Gestión Medioambiental con certificación ISO 14001.

Nuestra misión, es "Ofrecer a todos nuestros clientes una solución segura y fiable en altura" con el máximo compromiso y responsabilidad en el diseño y fabricación de nuestros productos.



PROJECTS	06
PRO SERIES	08
ENERGY	38
VOLT	54
PARTS	62

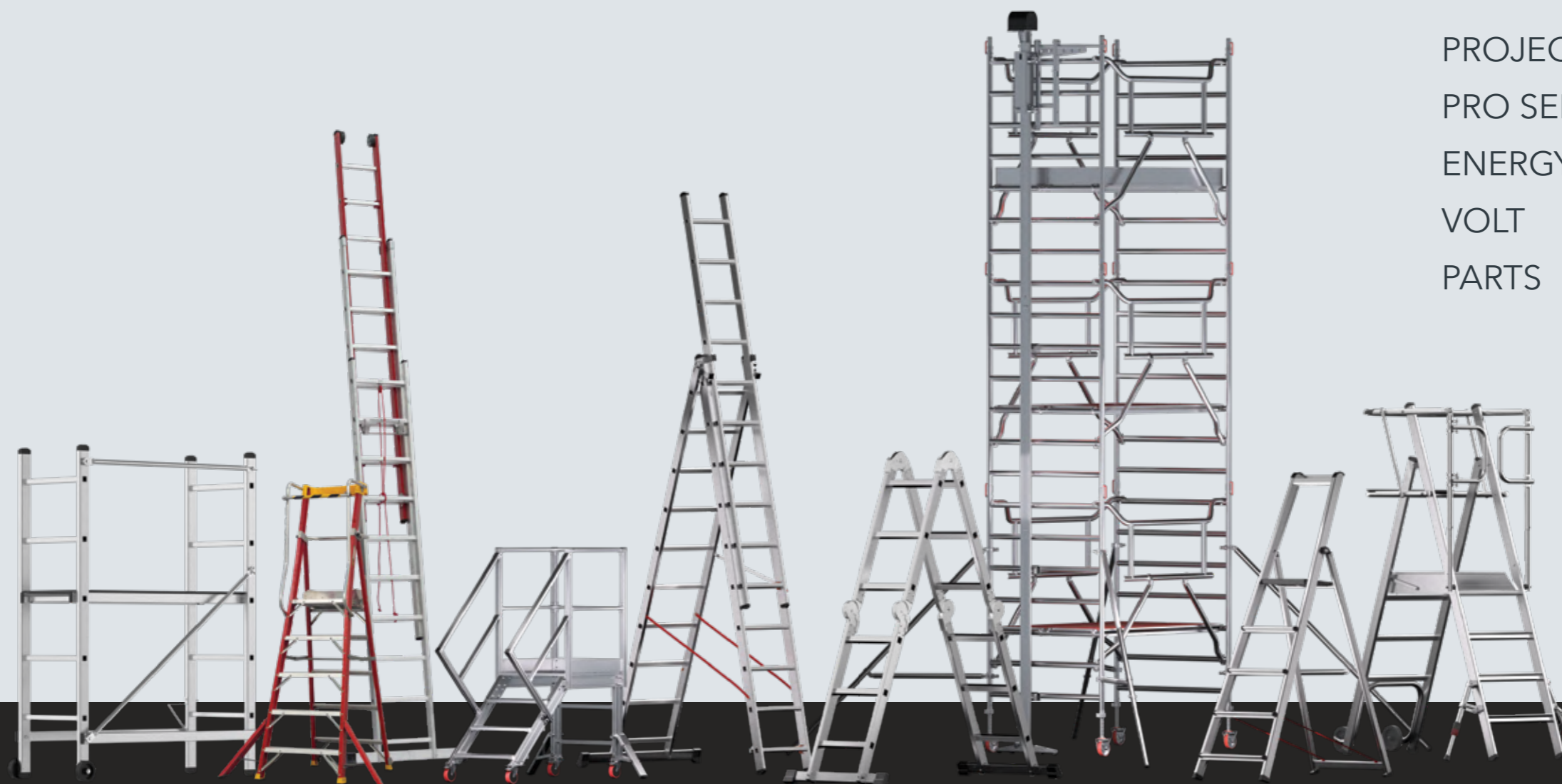



PROJECTS

Soluções de engenharia para desafios específicos.

Engineered solutions for unique challenges.

Solutions d'ingénierie pour des besoins spécifiques.

Soluciones de ingeniería para retos específicos.

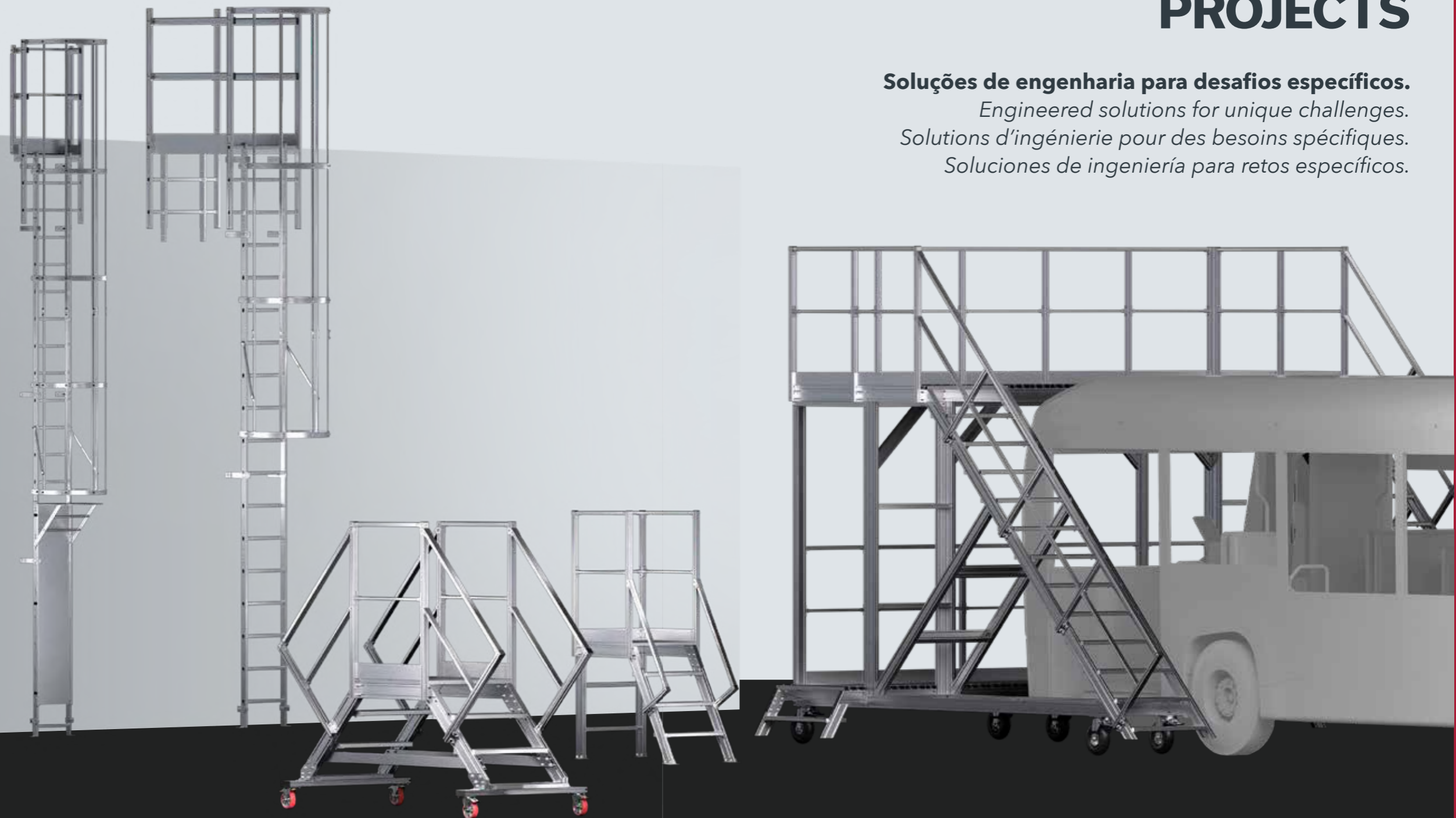



PRO SERIES

Equipamento para os mais profissionais.

Equipment for hardworking people.

Équipement pour les plus professionnels.

Equipo para los más profesionales.



EXTRA

Escadote profissional em alumínio - Soldadura Robotizada. Degraus antiderrapantes (120 mm) e plataforma (290 mm) com largura Extra, articulações de alta qualidade e porta ferramentas. Cintas de segurança e pés antiderrapantes Extra.

Professional aluminium stepladder - Robotic Welding. Extra deep tread non-slip steps (120 mm) and platform (290 mm), high quality hinges and tool holder. Safety straps and Extra slip-resistant feet.

Escabeau professionnel en aluminium - Soudage Robotique. Marches antidérapantes (120 mm) et plateforme (290 mm) Extra-larges, charnières de haute qualité et porte-outils. Sangles de sécurité et sabot emboitable antidérapant Extra.

Escalera profesional de aluminio - Soldadura Robótica. Peldaños antideslizantes (120 mm) y plataforma (290 mm) Extra anchos, bisagras de alta calidad y bandeja porta-herramientas. Cintas de seguridad y tacos antideslizantes Extra.



5604620023132	3	0,66m	2,66m	1,29m	0,49m	1,40m	0,12m	5,49kg
	4	0,88m	2,88m	1,52m	0,51m	1,66m	0,12m	6,61kg
5604620023156	5	1,10m	3,10m	1,71m	0,53m	1,88m	0,12m	7,74kg
	6	1,33m	3,33m	1,95m	0,56m	2,11m	0,12m	9,19kg
5604620023170	7	1,57m	3,57m	2,17m	0,58m	2,38m	0,12m	10,41kg
	8	1,80m	3,80m	2,40m	0,61m	2,61m	0,12m	11,66kg
5604620023194	9	2,01m	4,01m	2,64m	0,63m	2,89m	0,12m	12,95kg

EXTRA LIGHT SOB CONSULTA
EXTRA LIGHT UPON REQUEST
EXTRA LIGHT SUR DEMAND
EXTRA LIGHT BAJO CONSULTA

OPÇÃO
OPTION
OPTION
OPCIÓN



DUO

Escadote profissional de duplo acesso em alumínio - Soldadura Robotizada. Degraus antiderrapantes (120 mm) e articulações de segurança. Cintas de segurança e pés antiderrapantes Extra.

Professional aluminium double-sided stepladder - Robotic Welding. Extra deep tread non-slip steps (120 mm) and safety hinges. Safety straps and Extra slip-resistant feet.

Escabeau professionnel double accès en aluminium - Soudage Robotique. Marches antidérapantes Extra-larges (120 mm) et charnières de sécurité. Sangles de sécurité et sabot emboitable antidérapant Extra.

Escalera profesional de aluminio de doble acceso - Soldadura Robótica. Peldaños antideslizantes Extra-anchos (120 mm) y bisagras de alta seguridad. Cintas de seguridad y tacos antideslizantes Extra.



5604620023330	3	0,13m	2,13m	0,70m	0,46m	0,74m	0,23m	6,09kg
5604620023347	4	0,38m	2,38m	0,94m	0,48m	0,99m	0,23m	7,86kg
5604620023354	5	0,61m	2,61m	1,17m	0,50m	1,24m	0,23m	9,69kg
5604620023361	6	0,85m	2,85m	1,41m	0,53m	1,49m	0,23m	11,59kg
5604620023378	7	1,08m	3,08m	1,64m	0,56m	1,74m	0,23m	13,55kg
5604620023385	8	1,31m	3,31m	1,87m	0,59m	1,99m	0,23m	15,58kg

DUO LIGHT SOB CONSULTA
DUO LIGHT UPON REQUEST
DUO LIGHT SUR DEMAND
DUO LIGHT BAJO CONSULTA

OPÇÃO
OPTION
OPTION
OPCIÓN



PROTECT

Plataforma profissional de trabalho portátil em alumínio com guarda-corpos de segurança. Proteção traseira, portas de acesso automáticas e porta ferramentas. Degraus (60 mm) e plataforma alargados (455x600 mm) para reforçar o conforto e a resistência do produto. Facilidade de transporte e arrumação.

Aluminium professional mobile working platform with safety guardrails. Fall protection safety gates with automatic mechanism and toolholder. Large steps (60 mm) and platform (455x600 mm) to improve comfort and increase performance of the product. Easy transport and storage.

Plateforme Individuelle Roulante Légère (PIRL) professionnelle en aluminium avec garde-corps. Portillon à fermeture automatique, porte-outils y tablette porte bidon. Construction robuste avec marches (60 mm) et plateforme (455x600 mm) de grande dimension pour améliorer le confort. Facile à transporter et à stocker.

Plataforma de móvil profesional de aluminio con barandillas de seguridad. Protección trasera, puerta automática y bandeja porta-herramientas. Peldaños (60 mm) y plataforma (455x600 mm) anchos para máxima comodidad y reforzar al máximo la resistencia del producto. Fácil almacenamiento y transporte.



Barcode	Stairs	A ₁	A ₂	A ₃	Platform	Wheel	Height	Width	Weight
---------	--------	----------------	----------------	----------------	----------	-------	--------	-------	--------

5604620060021	2	0,47m	2,47m	1,57m	0,55m	-	1,97m	0,38m	17,20kg
5604620060038	3	0,70m	2,70m	1,77m	0,55m	0,90m	2,23m	0,38m	19,37kg
5604620060045	4	0,94m	2,94m	2,01m	0,55m	0,90m	2,48m	0,38m	20,67kg
5604620060052	5	1,17m	3,17m	2,24m	0,55m	1,20m	2,72m	0,38m	22,24kg
5604620060069	6	1,41m	3,41m	2,48m	0,55m	1,60m	2,98m	0,38m	24,10kg
5604620060076	7	1,64m	3,64m	2,71m	0,55m	1,67m	3,23m	0,38m	25,40kg
5604620060083	8	1,88m	3,88m	2,94m	0,55m	1,96m	3,49m	0,38m	26,73kg

PROTECT LIGHT SOB CONSULTA
 PROTECT LIGHT UPON REQUEST
 PROTECT LIGHT SUR DEMAND
 PROTECT LIGHT BAJO CONSULTA

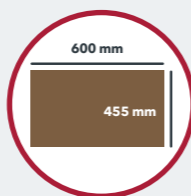

PROTECT FLEX

Plataforma telescópica profissional de trabalho portátil em alumínio com guarda-corpos de segurança. Proteção traseira, portas de acesso automáticas e porta ferramentas. Degraus (60mm) e plataforma alargados (455x600mm) para reforçar o conforto e a resistência do produto. Altura de trabalho ajustável (ideal para utilização em superfícies desniveladas), facilidade de transporte e arrumação.

Aluminium professional telescopic mobile working platform with safety guardrails. Fall protection safety gates with automatic mechanism and toolholder. Large steps (60mm) and platform (455x600mm) to improve comfort and increase performance of the product. Simple height adjustment (adjustable on uneven surfaces), easy transport and storage.

Plateforme Individuelle Roulante Légère (PIRL) télescopique professionnelle en aluminium avec garde-corps. Portillon à fermeture automatique, porte-outils y tablette porte bidon. Construction robuste avec marches (60mm) et plateforme (455x600mm) de grande dimension pour améliorer le confort. Utilisable dans les escaliers, facile à transporter et à stocker.

Plataforma telescópica de trabajo móvil profesional de aluminio con barandillas de seguridad. Protección trasera, puerta automática y bandeja porta-herramientas. Peldaños (60mm) y plataforma (455x600mm) anchos para máxima comodidad y reforzar al máximo la resistencia del producto. Altura de trabajo regulable (Ideal para trabajos en desnivel), fácil almacenamiento y transporte.



Barcode	Stairs	A ₁	A ₂	A ₃	Platform	Wheel	Height	Width	Weight
---------	--------	----------------	----------------	----------------	----------	-------	--------	-------	--------

5604620060137	3-4	Min 0,69m Max 0,93m	Min 2,69m Max 2,93m	Min 1,77m Max 2,00m	0,67m	-	2,20m	0,49m	24,23kg
5604620060144	4-6	Min 0,93m Max 1,40m	Min 2,93m Max 3,40m	Min 2,21m Max 2,46m	0,67m	1,40m	2,47m	0,49m	28,17kg
5604620060151	5-8	Min 1,16m Max 1,87m	Min 3,16m Max 3,87m	Min 2,24m Max 2,94m	0,67m	1,78m	2,71m	0,49m	31,52kg

PROTECT FLEX LIGHT SOB CONSULTA
 PROTECT FLEX LIGHT UPON REQUEST
 PROTECT FLEX LIGHT SUR DEMAND
 PROTECT FLEX LIGHT BAJO CONSULTA

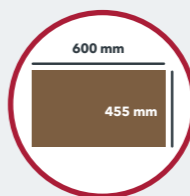

PODIUM

Plataforma de trabalho móvel em alumínio. Rodas giratórias, degraus (120 mm) e plataforma alargados (455x600 mm) para reforçar o conforto e a resistência do produto, porta ferramentas e corrimão de segurança. Facilidade de montagem e transporte. Ideal para utilização em armazéns.

Mobile aluminium warehouse platform. Castors wheels, large steps (120 mm) and platform (455x600 mm) to improve comfort and increase performance of the product, tool holder and safety handrails. Easy assembly and transport. Ideal for use in warehouses.

Plateforme individuelle roulante en aluminium. Roues pivotantes, construction robuste avec marches (120 mm) et plateforme (455x600 mm) de grande dimension pour améliorer le confort, porte-outils et rampes de sécurité. Montage et transport facile. Idéale pour une utilisation dans les entrepôts.

Plataforma de trabajo de aluminio móvil. Ruedas giratorias, peldaños (120 mm) y plataforma (455x600 mm) anchos para máxima comodidad y reforzar al máximo la resistencia del producto, porta herramientas y pasamanos de seguridad. Facilidad de montaje y transporte. Ideal para uso en almacenes.

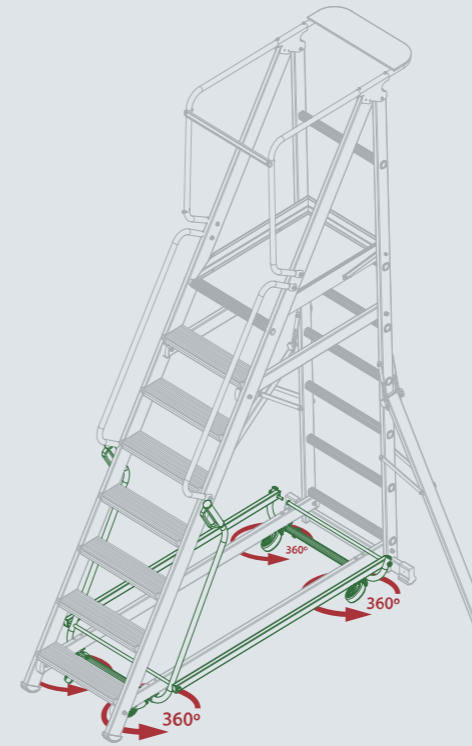

PODIUM

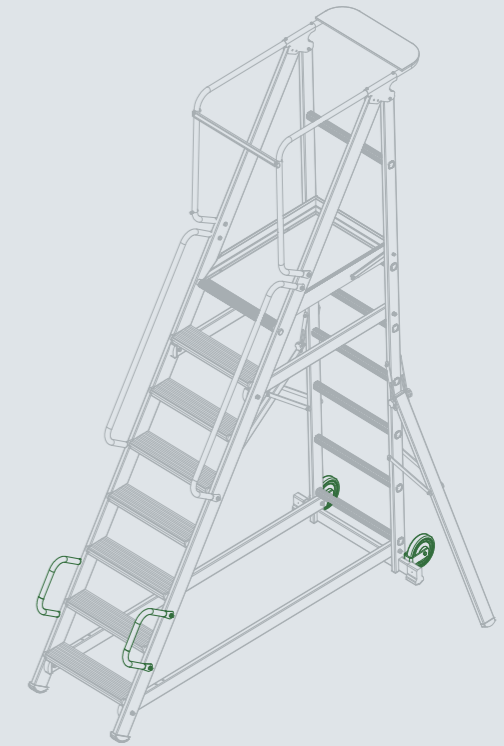

PODIUM LIGHT

Barcode	Steps	Height	Width	Depth	Step Height	Platform Length	Platform Width	Weight
5604620150050	5	1,10m	3,10m	2,00m	0,58m	3,13m	0,24m	32,09kg
5604620150067	6	1,30m	3,30m	2,20m	0,58m	3,37m	0,24m	32,66kg
5604620150074	7	1,50m	3,50m	2,40m	0,62m	3,62m	0,24m	33,66kg
5604620150081	8	1,70m	3,70m	2,60m	0,62m	3,86m	0,24m	35,63kg
5604620150098	9	1,90m	3,90m	2,80m	0,62m	4,11m	0,24m	41,93kg
5604620150104	10	2,10m	4,10m	3,00m	0,62m	4,35m	0,24m	43,84kg
5604620150111	11	2,30m	4,30m	3,20m	0,62m	4,60m	0,24m	50,57kg
5604620150128	12	2,50m	4,50m	3,40m	0,62m	4,84m	0,24m	57,23kg

JOKER

Escadote profissional em alumínio extra-largo com arco de segurança. Plataformas alargadas (230x360 mm) antiderrapantes e porta ferramentas. Facilidade de transporte e arrumação.

Extra-large folding stepladder with safety rail. Large non-slip rubber steps (230x360 mm) and toolholder. Easy to transport and storage.

Marchepied extra-large avec garde corps. Marches de grande dimension (230x360 mm) avec tapis antidérapants y porte-outils. Facile à transporter et à stocker.

Escalera extra-ancha con arco de seguridad. Peldaños anchos antideslizantes (230x360 mm) y bandeja porta-herramientas. Fácil almacenamiento y transporte.



5604620015120	2	0,44m	2,44m	0,81m	0,53m	0,80m	0,12m	7,77kg
5604620015137	3	0,66m	2,66m	1,28m	0,53m	1,12m	0,12m	10,47kg
5604620015144	4	0,88m	2,88m	1,49m	0,53m	1,42m	0,12m	13,47kg



PROGRESS

Escada telescópica profissional em alumínio Degrau antiderrapante confortável de 40x40mm com tecnologia de fecho suave (soft closing). Tacos antiderrapantes. Facilidade de transporte e arrumação.

Professional aluminium telescopic ladder. Soft closing technology with comfortable non-slip rung 40x40mm. Slip-resistant feet. Easy transport and storage.

Échelle télescopique professionnelle en aluminium. Technologie de fermeture douce (soft closing) avec échelons antidérapants confortables de 40x40mm. Sabots antidérapants. Transport et stockage aisés.

Escalera telescópica profesional de aluminio. Tecnología de cierre suave (soft closing) con cómodo peldaño antideslizante de 40x40mm. Patas antideslizantes. Fácil transporte y almacenamiento.



5604620001239	9	2,61m	2,52m	3,65m	0,47m	0,78m	0,08m	77x49x9cm	9,00kg
5604620001246	13	3,81m	3,68m	4,81m	0,89m	0,93m	0,09m	89x52x10cm	15,00kg

TELEFLEX

Escada articulada telescópica profissional em alumínio. Utilizável em 3 posições diferentes: escada extensível, posição de escadote e em superfícies desniveladas. Degrau antiderrapante confortável (30x30 mm) e largura interior da escada com 300 mm. Articulações Multiflex, sistema de bloqueio da parte deslizante e tacos antiderrapantes. Estabilizador Jumbo para máxima estabilidade e preparado para superfícies irregulares.

Aluminium professional multi-purpose telescopic ladder. Ladder can be used in 3 different positions: extension ladder position, standing position and working on uneven ground. Comfortable non-slip rung (30x30 mm) and inner width of the ladder 300 mm. Multiflex hinges, sliding mechanism with locks and slip-resistant feet. Jumbo stabilizer for maximum stability and prepared for uneven surfaces.

Échelle pliante télescopique professionnelle en aluminium. Utilisable en 3 positions différentes: échelle simple, autostable et en dénivelés. Échelons antidérapant confortable de (30x30 mm) et largeur intérieure de l'échelle de 300 mm. Articulation multiflex, système de blocage du plan coulissant et sabots antidérapants. Stabilisateur Jumbo pour une stabilité optimale et préparé pour les surfaces inégales.

Escalera telescópica multifunción profesional de aluminio. La escalera se puede cambiar en 3 posiciones diferentes: extensible, tijera y para trabajo en desnivel. Cómodo peldaño antideslizante de (30x30 mm) y ancho interior de la escalera de 300 mm. Bisagras Multiflex, sistema de posicionamiento con agarre y patas antideslizantes. Estabilizador Jumbo para máxima estabilidad y preparado para superficies irregulares.



5604620001345	3+3	0,94m	2,91m	2,81m	4,00m	1,49m	1,44m	2,63m	0,56m	0,22m	11,05kg
5604620001352	3+4	1,22m	3,47m	3,35m	4,54m	1,77m	1,71m	2,90m	0,56m	0,22m	12,00kg
5604620001369	4+4	1,22m	4,03m	3,89m	5,08m	2,05m	1,98m	3,17m	0,56m	0,22m	13,15kg
5604620001376	4+5	1,50m	4,59m	4,43m	5,62m	2,33m	2,25m	3,44m	0,56m	0,22m	14,09kg
5604620001413	5+5	1,50m	5,15m	4,97m	6,16m	2,61m	2,52m	3,71m	0,56m	0,22m	18,07kg



MULTIFLEX

Escada multifunções profissional em alumínio com plataforma. Utilizável em 3 posições diferentes: escada extensível, posição de escadote e bancada de trabalho (1400x300 mm). Degrau antiderrapante confortável (30x30 mm) e largura interior da escada com 300 mm. Articulações Multiflex e estabilizador antiderrapante.

Aluminium professional multi-purpose ladder with platform. Ladder can be used in 3 different positions: extension ladder position, standing position and work platform (1400x300 mm). Comfortable non-slip rung (30x30 mm) and inner width of the ladder 300 mm. Multiflex hinges and slip-resistant cross-beam.

Échelle multi positions professionnelle en aluminium avec plateforme. Utilisable en 3 positions différentes: échelle simple, autostable et plateforme de travail (1400x300 mm). Échelons antidérapant confortable (30x30 mm) et largeur intérieure de l'échelle de 300 mm. Articulation Multiflex et embase stabilisatrice antidérapant.

Escalera multifuncional profesional de aluminio con plataforma. La escalera se puede cambiar en 3 posiciones: extensible, tijera y plataforma de trabajo (1400x300 mm). Cómodo peldaño antideslizante (30x30 mm) y ancho interior de la escalera de 300 mm. Bisagras Multiflex y patas antideslizantes.



5604620013201	4x3	0,96m	3,52m	3,40m	4,59m	1,77m	1,71m	2,90m	1,00m	3,00m	0,35m	0,27m	16,26kg
---------------	-----	-------	-------	-------	-------	-------	-------	-------	-------	-------	-------	-------	---------

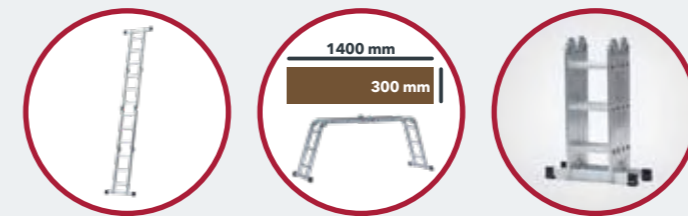

ELITE X1

Escada profissional simples, de 1 lance, em alumínio. Degrau antiderrapante confortável (30x30 mm) e largura interior da escada com 300 mm. Tacos antiderrapantes e estabilizador de segurança (antiderrapante) a partir de 12 degraus.

Aluminium professional single section rung ladder. Comfortable non-slip rung (30x30 mm) and inner width of the ladder 300 mm. Slip-resistant feet and safety cross-beam (slip-resistant) from 12 rungs.

Échelle professionnelle simple 1 plan en aluminium. Échelons antidérapant confortable (30x30 mm) et largeur intérieure de l'échelle de 300 mm. Sabots antidérapants et embase stabilisatrice (antidérapant) pour plus de sécurité dès 12 échelons.

Escalera industrial profesional de aluminio simple de 1 tramo. Cómodo peldaño antideslizante (30x30 mm) y ancho interior de la escalera de 300 mm. Patas antideslizantes y base estabilizadora (antideslizante) de seguridad a partir de 12 peldaños.



5604620130069	6	1,76m	1,70m	2,89m	0,35m	60mm	3,01kg
5604620130076	7	2,04m	1,97m	3,16m	0,35m	60mm	3,46kg
5604620130083	8	2,32m	2,25m	3,43m	0,35m	60mm	3,91kg
5604620130090	9	2,60m	2,52m	3,70m	0,35m	60mm	4,36kg
5604620130106	10	2,88m	2,79m	3,97m	0,35m	60mm	4,81kg
5604620130120	12	3,44m	3,33m	4,52m	0,35m	60mm	6,26kg
5604620130144	14	4,00m	3,87m	5,06m	0,35m	66mm	7,52kg
5604620130168	16	4,56m	4,41m	5,60m	0,35m	66mm	8,51kg
5604620130182	18	5,12m	4,95m	6,01m	0,35m	73mm	10,07kg
5604620130205	20	5,68m	5,49m	6,68m	0,35m	73mm	12,29kg



ELITE X2

Escada profissional transformável de 2 lances em alumínio. Gancho profissional e de fácil utilização para transformar a escada em posição de escadote. Degrau antiderrapante confortável (30x30 mm) e largura interior da escada com 300 mm. Estabilizador antiderrapante e cintas de segurança.

Aluminium professional 2 section combination ladder. Professional and easy-to-use hook to transform the ladder in standing position. Comfortable non-slip rung (30x30 mm) and inner width of the ladder 300 mm. Slip-resistant cross-beam and safety straps.

Échelle professionnelle transformable 2 plans en aluminium. Articulation professionnel et facile à utiliser pour transformer l'échelle en position autostable. Échelons antidérapant confortable (30 x 30 mm) et largeur intérieure de l'échelle de 300 mm. Embase stabilisatrice antidérapant et sangles de sécurité.

Escalera industrial profesional de aluminio de 2 tramos. Gancho profesional y fácil de utilizar para transformar la escalera en posición de tijera. Cómodo peldaño antideslizante (30 x 30 mm) y ancho interior de la escalera de 300 mm. Base estabilizadora antideslizante y cintas de seguridad.

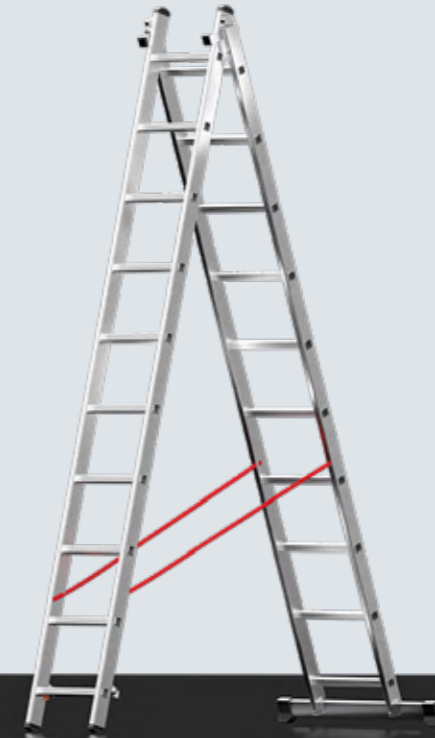
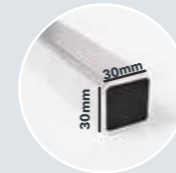

5604620230066	2x6	1,76m	2,88m	2,79m	3,97m	1,76m	1,70m	2,89m	0,41m	0,12m	7,53kg
5604620230073	2x7	2,04m	3,44m	3,33m	4,52m	2,04m	1,97m	3,16m	0,41m	0,12m	8,46kg
5604620230080	2x8	2,32m	4,00m	3,87m	5,06m	2,32m	2,25m	3,43m	0,41m	0,12m	9,43kg
5604620230097	2x9	2,60m	4,28m	4,14m	5,33m	2,60m	2,52m	3,70m	0,41m	0,12m	10,36kg
5604620230103	2x10	2,88m	4,84m	4,68m	5,87m	2,88m	2,79m	3,97m	0,41m	0,13m	11,82kg
5604620230127	2x12	3,44m	5,96m	5,76m	6,95m	3,44m	3,33m	4,52m	0,41m	0,14m	15,45kg
5604620230141	2x14	4,00m	6,80m	6,57m	7,76m	4,00m	3,87m	5,06m	0,41m	0,14m	18,51kg

OPÇÃO
OPTION
OPTION
OPCIÓN

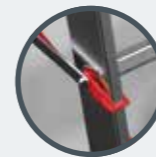

ELITE X3

Escada profissional transformável de 3 lances em alumínio. Degrau antiderrapante confortável (30x30 mm) e largura interior da escada com 300 mm. Gancho profissional e de fácil utilização para transformar a escada em posição de escadote. Estabilizador antiderrapante e cintas de segurança.

Aluminium professional 3 section combination ladder. Professional and easy-to-use hook to transform the ladder in standing position. Comfortable non-slip rung (30x30 mm) and inner width of the ladder 300 mm. Slip-resistant cross-beam and safety straps.

Échelle professionnelle transformable 3 plans en aluminium. Articulation professionnel et facile à utiliser pour transformer l'échelle en position autostable. Échelons antidérapant confortable de (30x30 mm) et largeur intérieure de l'échelle de 300 mm. Embase stabilisatrice antidérapant et sangles de sécurité.

Escalera industrial profesional transformable de aluminio de 3 tramos. Gancho profesional y fácil de utilizar para transformar la escalera en posición de tijera. Cómodo peldaño antideslizante de 30 x 30 mm y ancho interior de la escalera de 300 mm. Base estabilizadora antideslizante y cintas de seguridad.



5604620330063	3x6	1,76m	4,00m	3,87m	5,06m	2,88m	2,78m	3,97m	0,48m	0,18m	11,42kg
5604620330070	3x7	2,04m	4,56m	4,41m	5,60m	3,16m	3,06m	4,25m	0,48m	0,18m	13,23kg
5604620330087	3x8	2,32m	5,12m	4,95m	6,14m	3,72m	3,60m	4,79m	0,48m	0,18m	15,00kg
5604620330094	3x9	2,60m	6,52m	6,30m	7,49m	4,28m	4,14m	5,33m	0,48m	0,19m	17,05kg
5604620330100	3x10	2,88m	6,80m	6,57m	7,76m	4,84m	4,68m	5,87m	0,48m	0,19m	19,32kg
5604620330124	3x12	3,44m	7,64m	7,38m	8,57m	5,68m	5,49m	6,68m	0,48m	0,20m	23,79kg

OPÇÃO
OPTION
OPTION
OPCIÓN

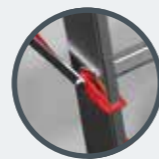

CORDA X2

Escada profissional de 2 lances extensível com corda em alumínio. Mecanismo de corda e rodas para facilitar a abertura da escada sem articulações laterais, prevenindo lesões na utilização do produto. Degrau antiderrapante confortável (30x30 mm) e largura interior da escada com 300 mm.

Aluminium professional 2 section extension ladder - rope operated. Rope mechanism and wheels to facilitate the opening of the ladder without side hinges, preventing injuries when using the product. Comfortable non-slip rung (30x30 mm) and inner width of the ladder 300mm.

Échelle professionnelle coulissante à corde 2 plans en aluminium. Mécanisme à corde et roues pour faciliter l'ouverture de l'échelle sans articulations latérales, évitant les blessures lors de l'utilisation du produit. Échelons antidérapant confortable de (30x30 mm) et largeur intérieure de l'échelle de 300 mm.

Escalera profesional extensible 2 tramos con cuerda de aluminio. Mecanismo de cuerda y ruedas para facilitar la apertura de la escalera sin bisagras laterales, evitando lesiones al utilizar el producto. Cómodo peldaño antideslizante de (30x30 mm) y ancho interior de la escalera de 300 mm.



5604620400100	2x10	2,88m	4,84m	4,68m	5,87m	0,41m	0,13m	14,87kg
5604620400124	2x12	3,44m	5,96m	5,76m	6,95m	0,41m	0,13m	17,41kg
5604620400148	2x14	4,00m	6,80m	6,57m	7,76m	0,41m	0,13m	20,54kg
5604620400162	2x16	4,56m	7,64m	7,38m	8,57m	0,41m	0,14m	23,97kg
5604620400186	2x18	5,12m	8,76m	8,46m	9,65m	0,41m	0,16m	28,10kg
5604620400209	2x20	5,68m	9,60m	9,28m	10,47m	0,41m	0,16m	30,86kg

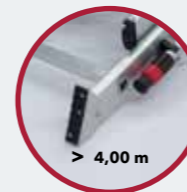

CORDA X3

Escada profissional de 3 lances extensível com corda em alumínio. Mecanismo de corda e rodas para facilitar a abertura da escada sem articulações laterais, prevenindo lesões na utilização do produto. Degrau antiderrapante confortável (30x30 mm) e largura interior da escada com 300 mm.

Aluminium professional 3 section extension ladder - rope operated. Rope mechanism and wheels to facilitate the opening of the ladder without side hinges, preventing injuries when using the product. Comfortable non-slip rung (30x30 mm) and inner width of the ladder 300 mm.

Échelle professionnelle coulissante à corde 3 plans en aluminium. Mécanisme à corde et roues pour faciliter l'ouverture de l'échelle sans articulations latérales, évitant les blessures lors de l'utilisation du produit. Echelons antidérapant confortable de (30x30 mm) et largeur intérieure de l'échelle de 300 mm.

Escalera profesional extensible 3 tramos con cuerda luminionio. Mecanismo de cuerda y ruedas para facilitar la apertura de la escalera sin bisagras laterales, evitando lesiones al utilizar el producto. Cómodo peldaño antideslizante de (30x30 mm) y ancho interior de la escalera de 300 mm.



5604620500107	3x10	2,88m	6,80m	6,57m	7,76m	0,48m	0,19m	21,33kg
5604620500121	3x12	3,44m	7,64m	7,38m	8,57m	0,48m	0,21m	27,24kg
5604620500145	3x14	4,00m	9,32m	9,01m	10,20m	0,48m	0,24m	34,56kg
5604620500169	3x16	4,56m	10,44m	10,09m	11,28m	0,48m	0,24m	38,82kg

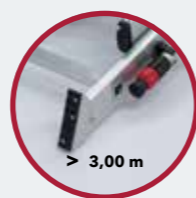

RÉGUAS

Réguas de alumínio.

Aluminium rullers.

Règles en aluminium.

Regles de aluminio.

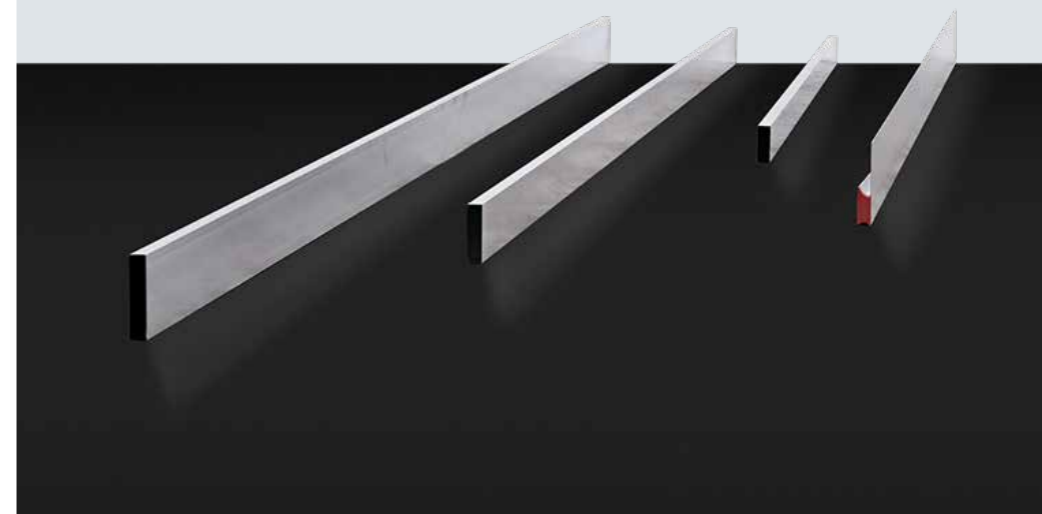

REF	REF.6	KG	REF.8	KG	REF.10	KG	REF.11	KG
1.00	1000x60x20mm	0,47kg	1000x80x20mm	0,59kg	1000x100x20mm	0,72kg	1000x110x20mm	1,11kg
1.50	1500x60x20mm	0,70kg	1500x80x20mm	0,88kg	1500x100x20mm	1,07kg	1500x110x20mm	1,66kg
2.00	2000x60x20mm	0,94kg	2000x80x20mm	1,17kg	2000x100x20mm	1,43kg	2000x110x20mm	2,21kg
2.50	2500x60x20mm	1,17kg	2500x80x20mm	1,47kg	2500x100x20mm	1,78kg	2500x110x20mm	2,76kg
3.00	3000x60x20mm	1,40kg	3000x80x20mm	1,76kg	3000x100x20mm	2,13kg	3000x110x20mm	3,30kg
3.50	3500x60x20mm	1,63kg	3500x80x20mm	2,05kg	3500x100x20mm	2,49kg	3500x110x20mm	3,85kg
4.00	4000x60x20mm	1,86kg	4000x80x20mm	2,34kg	4000x100x20mm	2,84kg	4000x110x20mm	4,40kg
5.00	5000x60x20mm	2,32kg	5000x80x20mm	2,92kg	5000x100x20mm	3,54kg	5000x110x20mm	5,50kg
6.00	6000x60x20mm	2,79kg	6000x80x20mm	3,50kg	6000x100x20mm	4,25kg	6000x110x20mm	6,60kg



PRESTIGE

Andaime modular profissional em alumínio. Construção soldada em tubos com diâmetro de 40 mm e espessura de 1.5 mm. Dimensão da plataforma 1710x640 mm, máxima estabilidade, com rodas giratórias e base dobrável. Montagem facilitada sem ferramentas. Não é necessário rebater os estabilizadores para movimentar o andaime.

Professional aluminium modular scaffold. Product developed in welded tubes with diameter 40 mm and thickness 1.5 mm. Platform dimension 1710x640 mm, increased stability, with castor wheels and folding base frame. Easy to assemble - no tools needed. It is not necessary to retract the stabilizers to move the scaffold.

Échafaudage roulant professionnel en aluminium. Produit développé en tubes soudés de diamètre 40 mm et épaisseur 1.5 mm. Dimension plateforme 1710x640 mm, stabilité optimale, roues pivotantes et base pliante. Montage rapide et sans outil. Il n'est pas nécessaire de rabattre les stabilisateurs pour déplacer l'échafaudage.

Andamio modular de aluminio profesional. Producto desarrollado en tubos soldados de 40 mm de diámetro y 1.5 mm de espesor. Dimensión plataforma 1710x640 mm, máxima estabilidad, con ruedas giratorias y base plegable. Fácil montaje (sin necesidad de herramientas). No es necesario recoger los estabilizadores para mover el andamio.

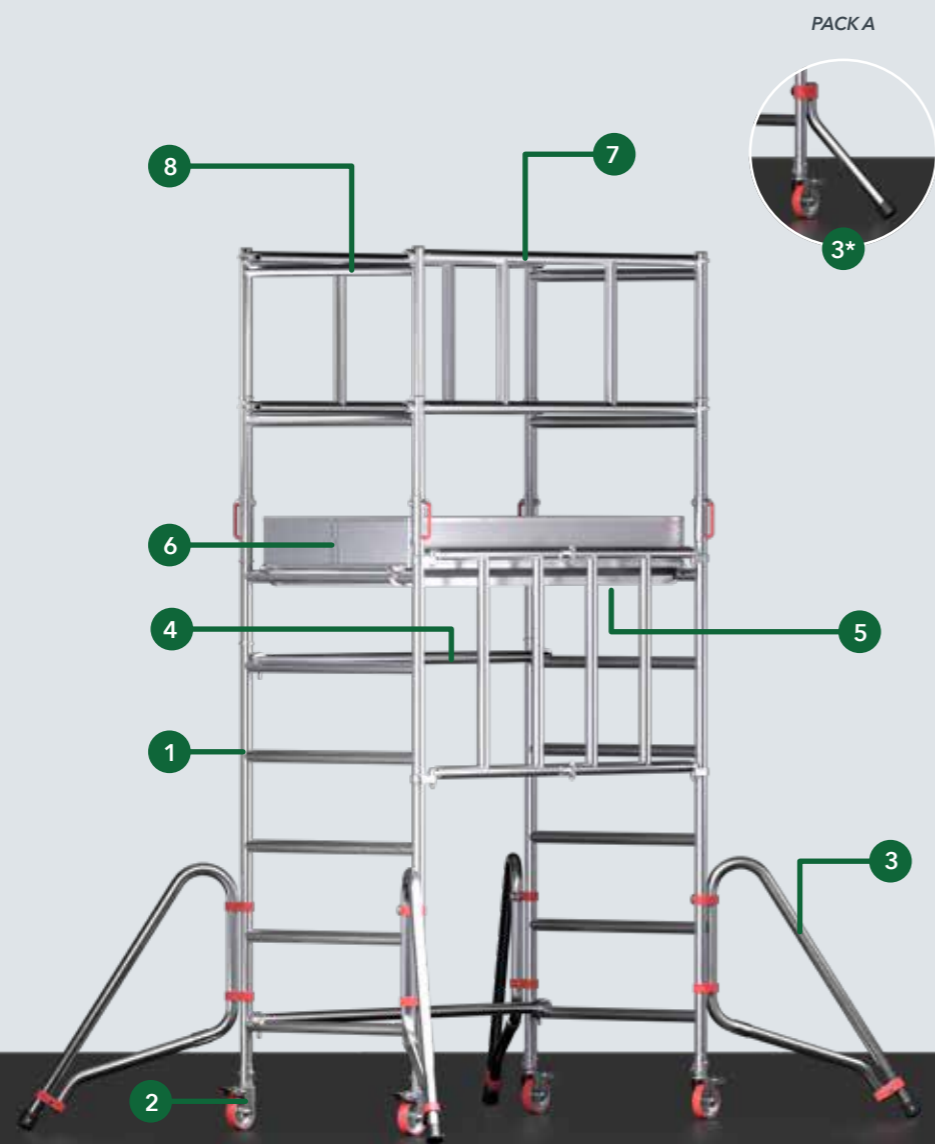

PRESTIGE

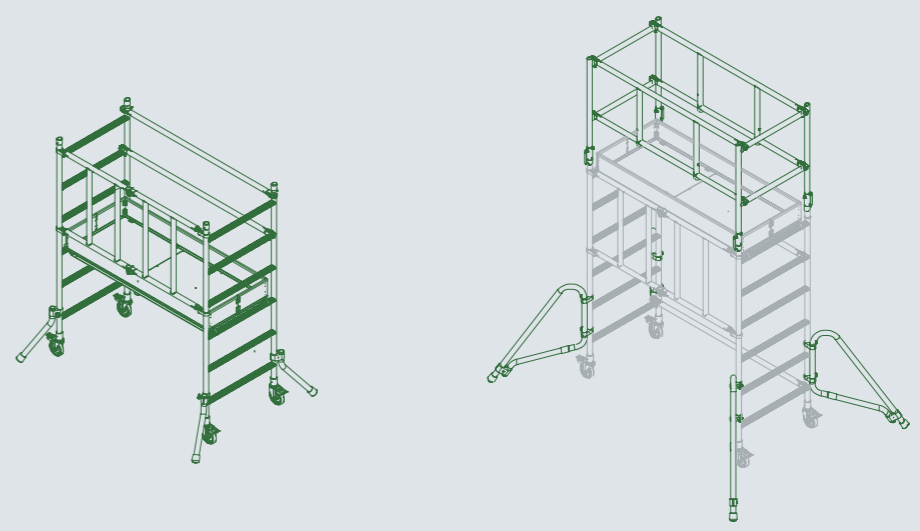

PACK A

PACK B (A+B)

PACKS	1	2	3*	3	4	5	6	7	8
	13,0kg	1,3kg	0,7kg	1,9kg	1,2kg	14,9kg	6,7kg	2,8kg	2,6kg
A	1	4	4	0	2	1	1	0	0
A+B	1	4	0	4	2	1	1	2	2

PACKS								
A	5604620460012	1,00m	3,00m	2,00m	1,85m	0,75m	44x189x83cm	41,89kg
A+B	5604620460043	1,90m	3,90m	2,90m	1,85m	0,75m	60x189x83cm	58,54kg



APEX 100

Andaime modular profissional em alumínio. Construção soldada em tubos com diâmetro de 50 mm e espessura de 2 mm. Dimensão da plataforma 1955x618 mm, máxima estabilidade e rodas giratórias ajustáveis em altura. Montagem facilitada sem ferramentas. Sistema Ferral RSG (Ready, Safe, Go!) integrado.

Professional aluminium modular scaffold. Product developed in welded tubes with diameter 50 mm and thickness 2 mm. Platform dimension 1955x618 mm, increased stability and height-adjustable castor wheels. Easy to assemble - no tools needed. Ferral RSG (Ready, Safe, Go!) integrated system.

Échafaudage roulant professionnel en aluminium. Produit développé en tubes soudés de diamètre 50 mm et épaisseur 2 mm. Dimension plateforme 1955x618 mm, stabilité optimale et roues pivotantes réglables en hauteur. Montage rapide et sans outil. Système Ferral RSG (Ready, Safe, Go!) intégré.

Andamio modular de aluminio profesional. Producto desarrollado en tubos soldados de 50 mm de diámetro y 2 mm de espesor. Dimensión plataforma 1955x618 mm, máxima estabilidad y ruedas giratorias de altura regulable. Fácil montaje (sin necesidad de herramientas). Sistema Ferral RSG (Ready, Safe, Go!) integrado.

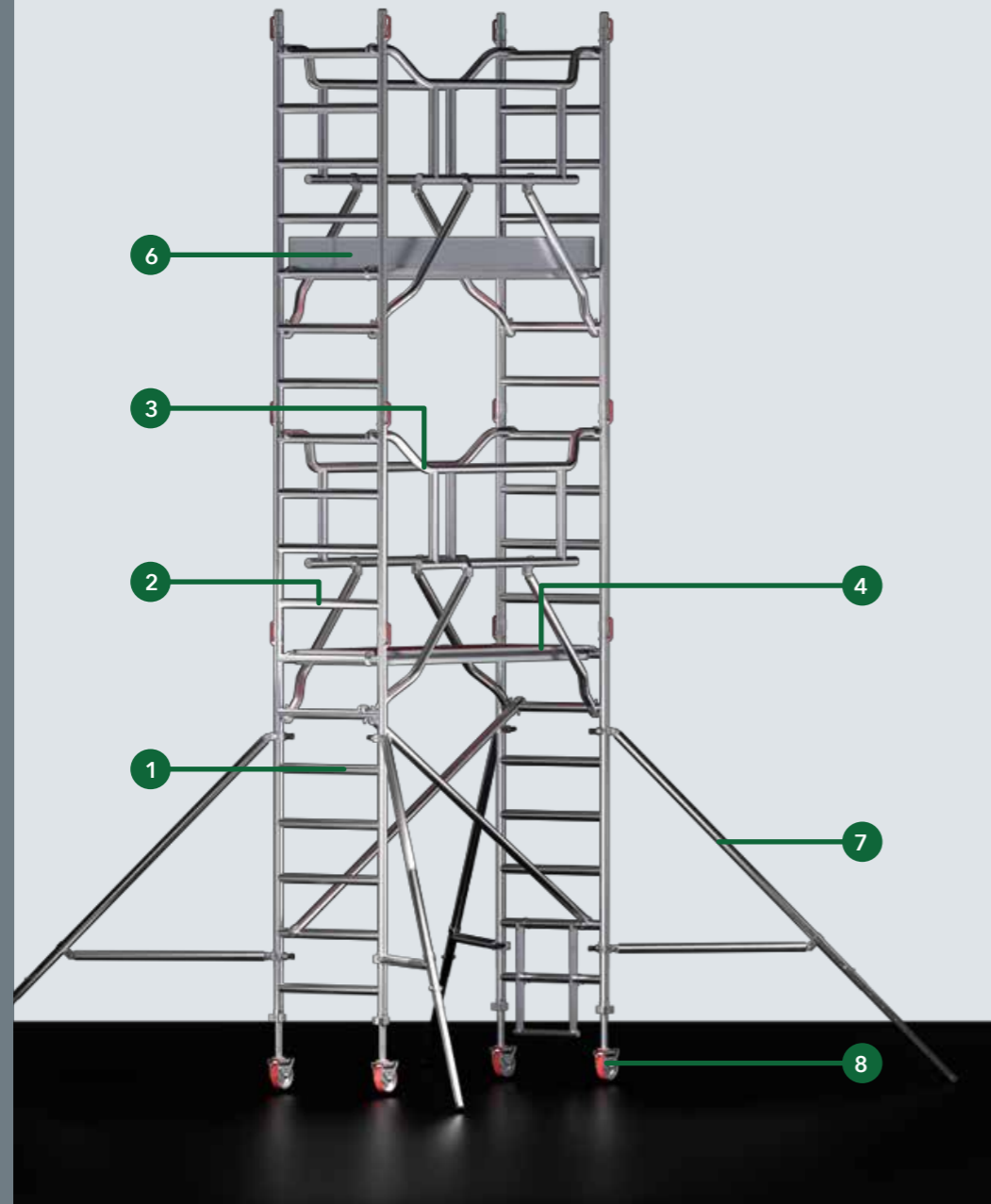

APEX 100

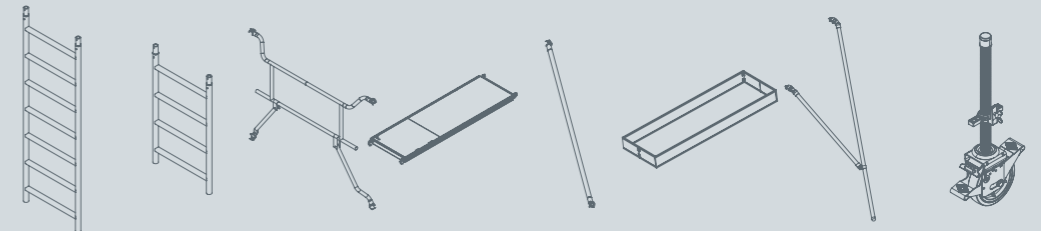

REF	1	2	3	4	5	6	7	8
	8,5kg	5,4kg	7,0kg	19,0kg	2,4kg	7,7kg	5,5kg (+)	2,3kg (**)
101	2	-	2	1	-	1	4	4
102	2	2	2	1	2	1	4	4
103	4	-	4	2	-	1	4	4
104	4	2	4	2	2	1	4	4
105	6	-	6	3	-	1	4	4
106	6	2	6	3	2	1	4	4
107	8	-	8	4	-	1	4	4
108	8	2	8	4	2	1	4	4
109	10	-	10	5	-	1	4	4
110	10	2	10	5	2	1	4	4
111	12	-	12	6	-	1	4	4

(*) para os andaimes | for the scaffolding | pour les échafaudages | para los andamios (106,107,108,109,110,111) - 6,1kg

(**) roda ajustável 150 | adjustable wheel 150 | roue réglable 150 | rueda ajustable 150 - 3,6kg
 roda ajustável 200 | adjustable wheel 200 | roue réglable 200 | rueda ajustable 200 - 5,3kg
 roda fixa 200 | fixed wheel 200 | roue fixe 200 | rueda fija 200 - 3,5kg

REF	Icon 1	Icon 2	Icon 3	Icon 4	Icon 5	Icon 6	Icon 7	Icon 8
101	5604620481017	1,10m	3,00m	2,40m	2.05m	725mm	82,82kg	
102	5604620481024	2,20m	4,20m	3,60m	2.05m	725mm	96,29kg	
103	5604620481031	3,10m	5,10m	4,50m	2.05m	725mm	129,52kg	
104	5604620481048	4,30m	6,30m	5,70m	2.05m	725mm	142,98kg	
105	5604620481055	5,20m	7,20m	6,60m	2.05m	725mm	176,21kg	
106	5604620481062	6,40m	8,40m	7,80m	2.05m	725mm	192,00kg	
107	5604620481079	7,30m	9,30m	8,70m	2.05m	725mm	225,23kg	
108	5604620481086	8,50m	10,50m	9,90m	2.05m	725mm	238,69kg	
109	5604620481093	9,40m	11,40m	10,80m	2.05m	725mm	271,92kg	
110	5604620481109	10,60m	12,60m	12,00m	2.05m	725mm	285,38kg	
111	5604620481116	11,50m	13,50m	12,90m	2.05m	725mm	318,61kg	



APEX 200

Andaime modular profissional em alumínio com dupla plataforma de trabalho. Construção soldada em tubos com diâmetro de 50 mm e espessura de 2 mm. Dimensão da plataforma 1955x618 mm, máxima estabilidade e rodas giratórias ajustáveis em altura. Montagem facilitada sem ferramentas. Sistema Ferral RSG (Ready, Safe, Go!) integrado.

Professional aluminium modular scaffold with double work platform. Product developed in welded tubes with diameter 50 mm and thickness 2 mm. Platform dimension 1955x618 mm, increased stability and height-adjustable castor wheels. Easy to assemble - no tools needed. Ferral RSG (Ready, Safe, Go!) integrated system.

Échafaudage roulant professionnel en aluminium avec double plate-forme de travail. Produit développé en tubes soudés de diamètre 50 mm et épaisseur 2 mm. Dimension plateforme 1955x618 mm, stabilité optimale et roues pivotantes réglables en hauteur. Montage rapide et sans outil. Système Ferral RSG (Ready, Safe, Go!) intégré.

Andamio modular de aluminio profesional com doble plataforma de trabajo. Producto desarrollado en tubos soldados de 50 mm de diámetro y 2 mm de espesor. Dimensión plataforma 1955x618 mm, máxima estabilidad y ruedas giratorias de altura regulable. Fácil montaje (sin necesidad de herramientas). Sistema Ferral RSG (Ready, Safe, Go!) integrado.

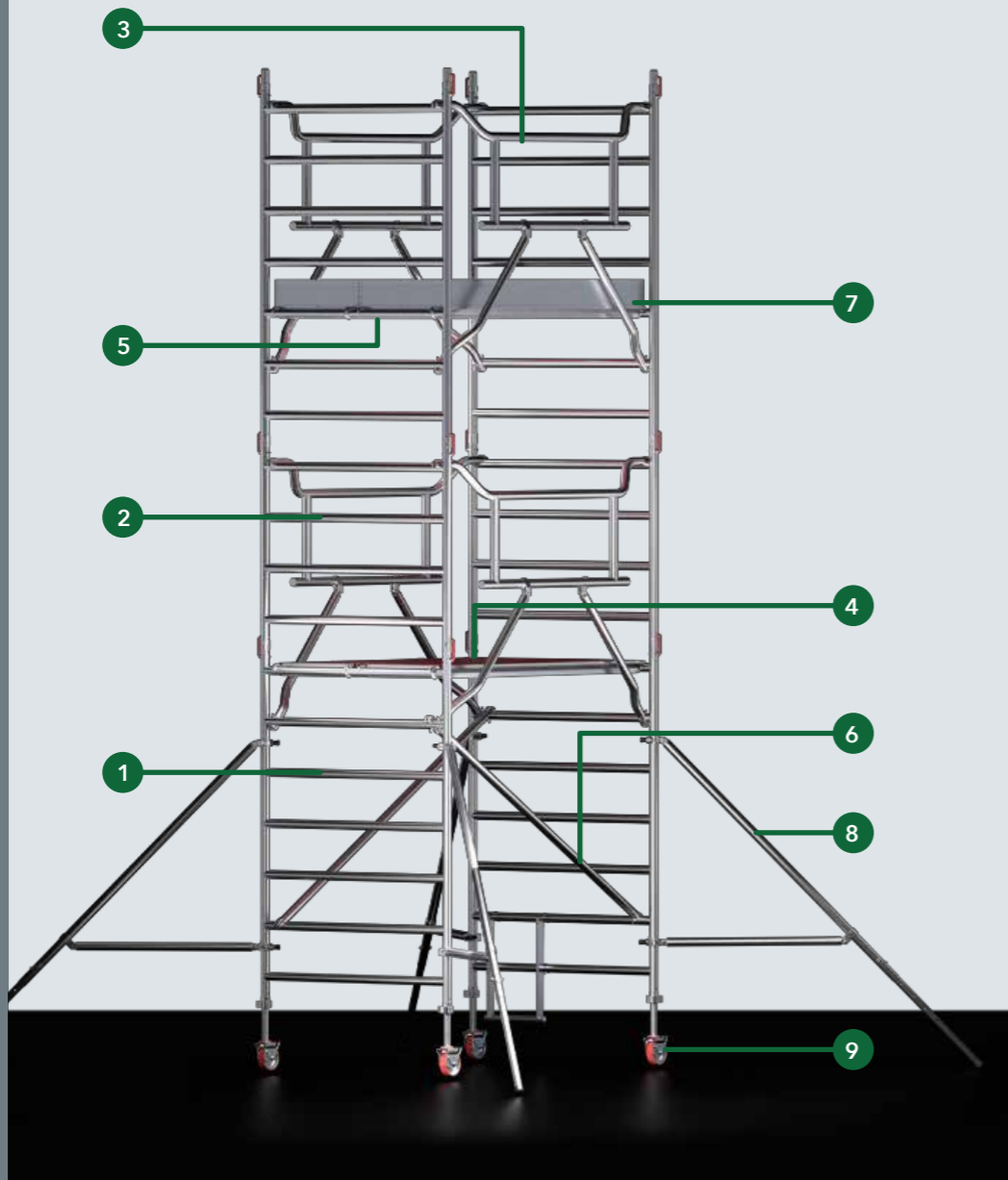

APEX 200

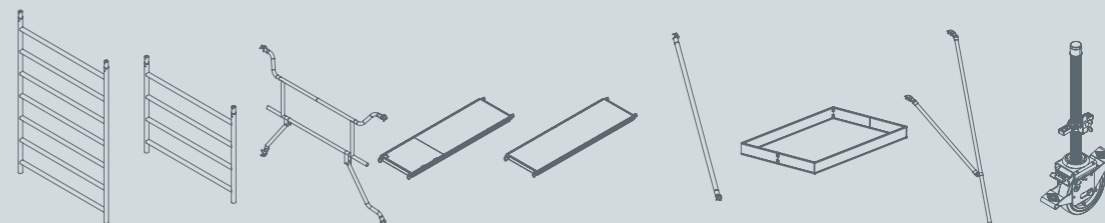

REF	1	2	3	4	5	6	7	8	9
	12,1kg	7,5kg	7,0 kg	19,0kg	18,9kg	2,4kg	9,5kg	5,5kg (+)	2,3kg (**)
201	2	-	2	1	1	-	1	4	4
202	2	2	2	1	1	2	1	4	4
203	4	-	4	2	2	-	1	4	4
204	4	2	4	2	2	2	1	4	4
205	6	-	6	3	3	-	1	4	4
206	6	2	6	3	3	2	1	4	4
207	8	-	8	4	4	-	1	4	4
208	8	2	8	4	4	2	1	4	4
209	10	-	10	5	5	-	1	4	4
210	10	2	10	5	5	2	1	4	4
211	12	-	12	6	6	-	1	4	4

(*) para os andaimes | for the scaffolding | pour les échafaudages | para los andamios (206,207,208,209,210,211) - 6,1kg

(**) roda ajustável 150 | adjustable wheel 150 | roue réglable 150 | rueda ajustable 150 - 3,6kg
 roda ajustável 200 | adjustable wheel 200 | roue réglable 200 | rueda ajustable 200 - 5,3kg
 roda fixa 200 | fixed wheel 200 | roue fixe 200 | rueda fija 200 - 3,5kg

REF	Barcode	Icon 1	Icon 2	Icon 3	Icon 4	Icon 5	Icon 6	Icon 7
201	5604620482014	1,20m	3,20m	2,20m	2,05m	1,40m	107,37kg	
202	5604620482021	2,40m	4,40m	3,40m	2,05m	1,40m	124,55kg	
203	5604620482038	3,30m	5,30m	4,30m	2,05m	1,40m	176,94kg	
204	5604620482045	4,50m	6,50m	5,50m	2,05m	1,40m	194,12kg	
205	5604620482052	5,40m	7,40m	6,40m	2,05m	1,40m	246,50kg	
206	5604620482069	6,60m	8,60m	7,60m	2,05m	1,40m	266,01kg	
207	5604620482076	7,50m	9,50m	8,50m	2,05m	1,40m	318,39kg	
208	5604620482083	8,70m	10,70m	9,70m	2,05m	1,40m	335,57kg	
209	5604620482090	9,60m	11,60m	10,60m	2,05m	1,40m	387,96kg	
210	5604620482106	10,80m	12,80m	11,80m	2,05m	1,40m	405,14kg	
211	5604620482113	11,70m	13,70m	12,70m	2,05m	1,40m	457,53kg	

NEW
DELTA

Andaime modular profissional em alumínio. Necessita apenas de uma pessoa para montar. Construção soldada em tubos com diâmetro de 50 mm e espessura de 2 mm. Dimensão da plataforma 1075x618 mm, máxima estabilidade e rodas giratórias ajustáveis em altura. Montagem facilitada sem ferramentas. Sistema Ferral RSG (Ready, Safe, Go!) integrado.

Professional aluminium modular scaffold. Can be assembled by one person. Product developed in welded tubes with diameter 50 mm and thickness 2 mm. Platform dimension 1075x618 mm, increased stability and height-adjustable castor wheels. Easy to assemble - no tools needed. Ferral RSG (Ready, Safe, Go!) integrated system.

Échafaudage roulant professionnel en aluminium. Peut être assemblé par une seule personne. Produit développé en tubes soudés de diamètre 50 mm et épaisseur 2 mm. Dimension plateforme 1075x618 mm, stabilité optimale et roues pivotantes réglables en hauteur. Montage rapide et sans outil. Système Ferral RSG (Ready, Safe, Go!) intégré.

Andamio modular de aluminio profesional. Puede ser ensamblado por una sola persona. Producto desarrollado en tubos soldados de 50 mm de diámetro y 2 mm de espesor. Dimensión plataforma 1075x618 mm, máxima estabilidad y ruedas giratorias de altura regulable. Fácil montaje (sin necesidad de herramientas). Sistema Ferral RSG (Ready, Safe, Go!) integrado.

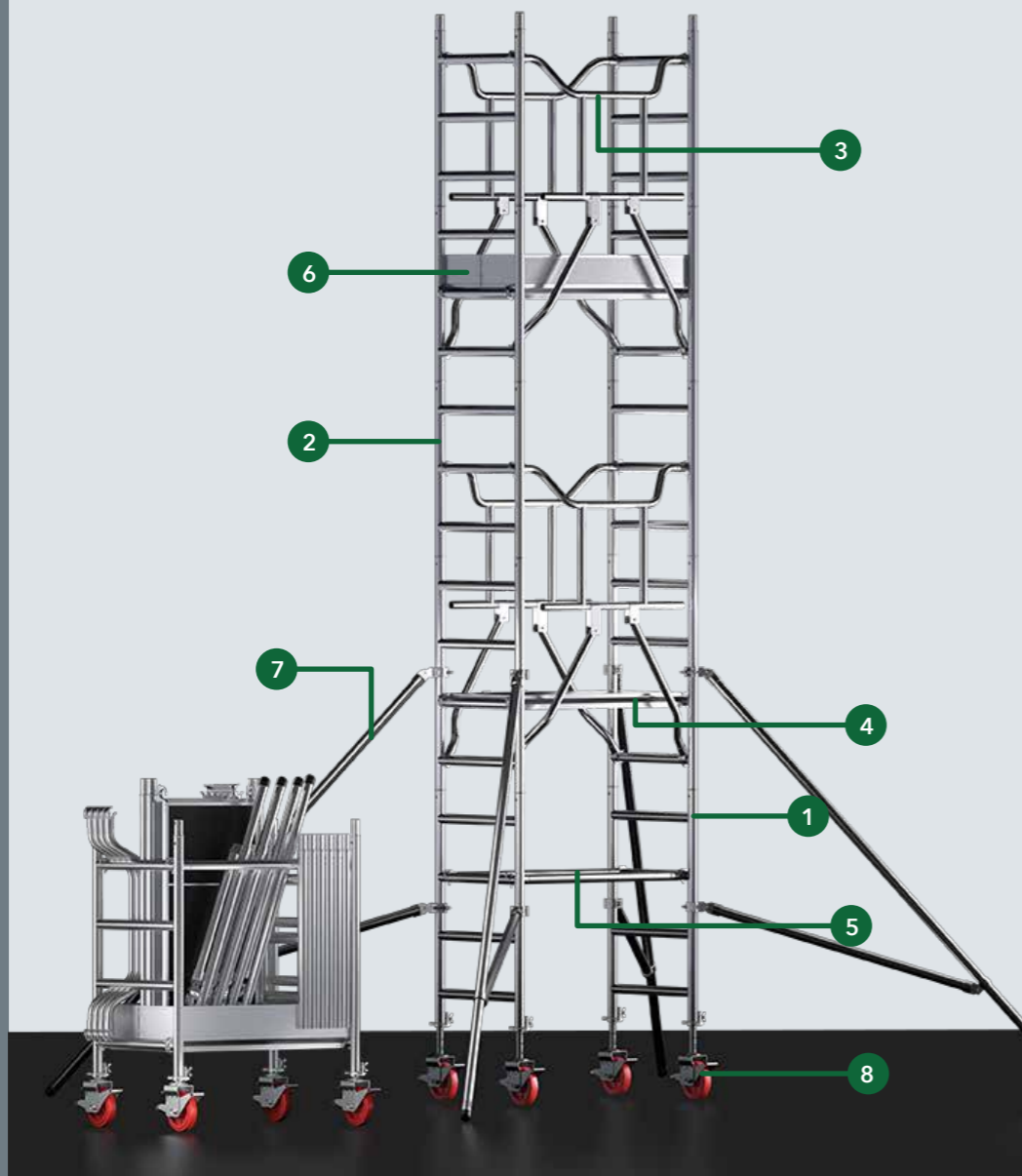

DELTA

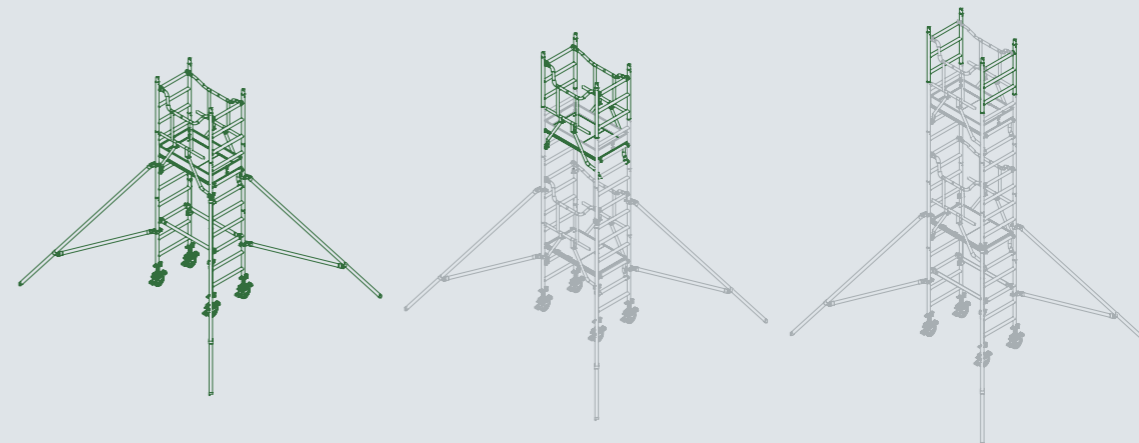

PACK A

PACK B (A+B)

PACK C (A+B+C)

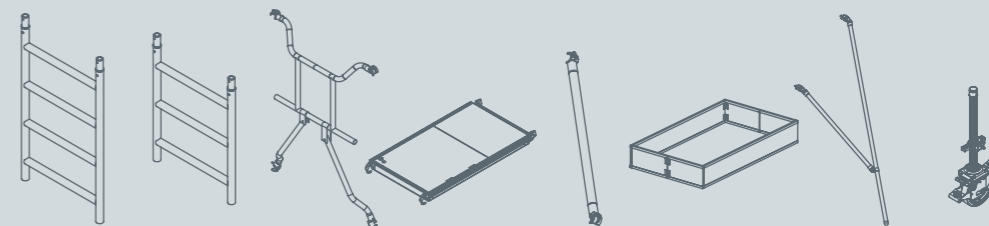

PACKS	1	2	3	4	5	6	7	8
A	2	4	2	1	4	1	4	4
A+B	4	4	4	2	4	1	4	4
A+B+C	4	6	4	2	4	1	4	4

PACKS								
A	5604620470011	2,00m	4,00m	3,00m	1,20m	750mm	90 kg	
A+B	5604620470042	3,20m	5,20m	4,20m	1,20m	750mm	120 kg	
A+B+C	5604620470059	4,10m	6,10m	5,10m	1,20m	750mm	130kg	

NEW
DUAL LIFT

Solução 2 em 1: funciona como uma escada extensível normal ou como um elevador de cargas, sem limitar a utilização normal da escada. Converte-se num sistema prático de elevação de cargas em menos de 1 minuto, quando necessário. Capacidade máxima de elevação (apenas cargas): até 100kg. Carga máxima do utilizador (uso como escada): até 150kg. Acionamento através de aparafusadora / berbequim a bateria standard. Instalação rápida, fácil e segura na estrutura da escada. Ideal para elevar ferramentas, materiais e equipamentos em altura de forma segura e eficiente.

2-in-1 solution: functions as a normal extension ladder or as a load lift, without restricting standard ladder use. Converts the ladder into a practical load lifting system in less than 1 minute, when required. Maximum lifting capacity (loads only): up to 100kg. Maximum user load (ladder use): up to 150kg. Operated using a standard cordless screwdriver/drill. Quick, easy and secure installation on the ladder structure. Ideal for lifting tools, materials and equipment to height safely and efficiently.

Solution 2 en 1: fonctionne comme une échelle coulissante standard ou comme un système de levage de charges, sans limiter l'utilisation normale de l'échelle. Se transforme en un système pratique de levage de charges en moins d'une minute, lorsque nécessaire. Capacité maximale de levage (charges uniquement): jusqu'à 100kg. Charge maximale utilisateur (utilisation comme échelle): jusqu'à 150kg. Fonctionnement à l'aide d'une visseuse/perceuse sans fil standard. Installation rapide, facile et sécurisée sur la structure de l'échelle. Idéal pour lever outils, matériaux et équipements en hauteur en toute sécurité et efficacité.

Solución 2 en 1: funciona como una escalera extensible normal o como un elevador de cargas, sin limitar el uso estándar de la escalera. Se convierte en un sistema práctico de elevación de cargas en menos de 1 minuto, cuando es necesario. Capacidad máxima de elevación (solo cargas): hasta 100kg. Carga máxima del usuario (uso como escalera): hasta 150kg. Accionamiento mediante atornillador/taladro a batería estándar. Instalación rápida, fácil y segura en la estructura de la escalera. Ideal para elevar herramientas, materiales y equipos a altura de forma segura y eficiente.



DUAL LIFT

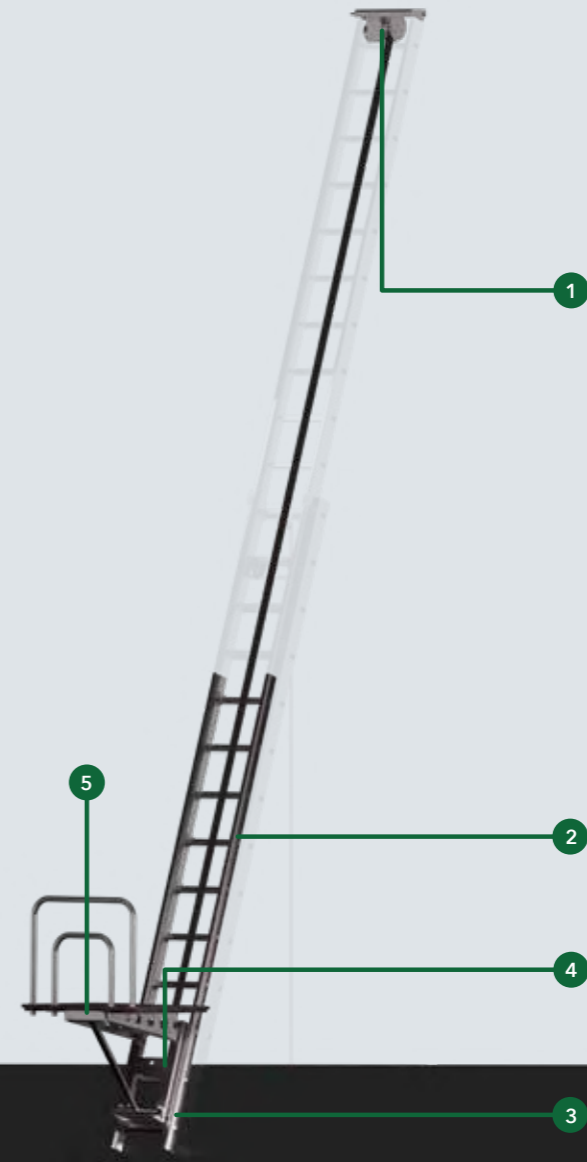

5604620812149	1	2	3	4	5
	8,50kg	3,95kg	2,25kg	4,00kg	14,00kg
2x14	4,00m	6,80m	6,57m	7,76m	0,47m
					0,17m
					27,00kg

NEW
RAIZR

Accessório de elevação de materiais integrado em andaimes para cargas até 75 kg. Acionamento através de aparafusadora/berbequim a bateria standard. Apenas para elevação de materiais - não destinado à elevação de pessoas. Sistema de guias quick-click, permitindo uma instalação rápida e intuitiva das guias. Carrier configurável para diferentes tipos de carga (por exemplo, painéis solares). Carrier rotativo opcional de 180°.

Scaffold-integrated material lifting accessory for loads up to 75 kg. Operated using a standard cordless screwdriver/drill. For lifting materials only - not for lifting persons. Quick-click guide system, allowing fast and intuitive installation of the guides. Configurable carrier for different load types (e.g. solar panels). Optional 180° rotating carrier.

Scaffold-integrated material lifting accessory for loads up to 75 kg. Fonctionnement à l'aide d'une visseuse/perceuse sans fil standard. For lifting materials only - not for lifting persons. Quick-click guide system, allowing fast and intuitive installation of the guides. Configurable carrier for different load types (e.g. solar panels). Optional 180° rotating carrier.

Accesorio de elevación de materiales integrado en andamios para cargas de hasta 75 kg. Accionamiento mediante atornillador/taladro a batería estándar. Solo para elevación de materiales - no apto para la elevación de personas. Sistema de guías quick-click que permite una instalación rápida e intuitiva de las guías. Portacargas configurable para diferentes tipos de carga (p. ej. paneles solares). Portacargas giratorio opcional de 180°.

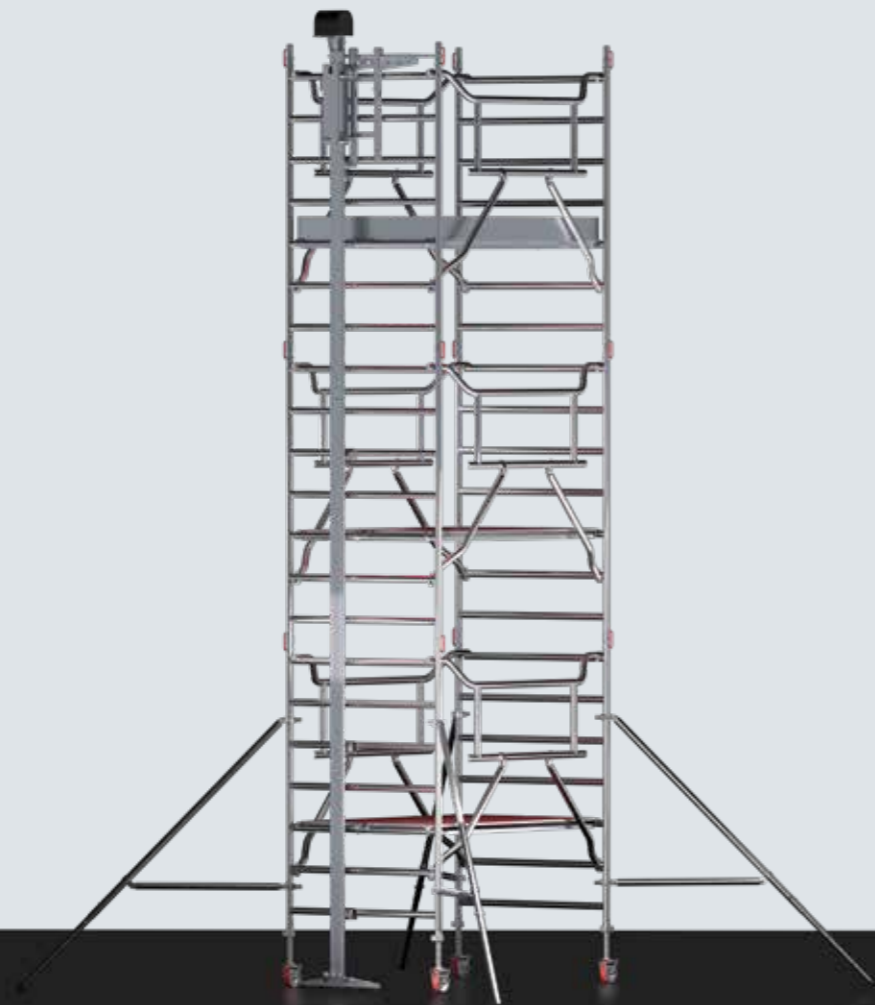

OPÇÃO (PAINÉIS SOLARES)
OPTION (SOLAR PANELS)
OPTION (PANNEAUX SOLAIRES)
OPCIÓN (PANELES SOLARES)

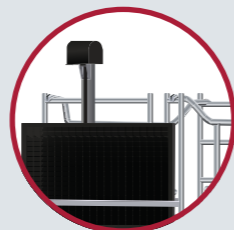

RAIZR

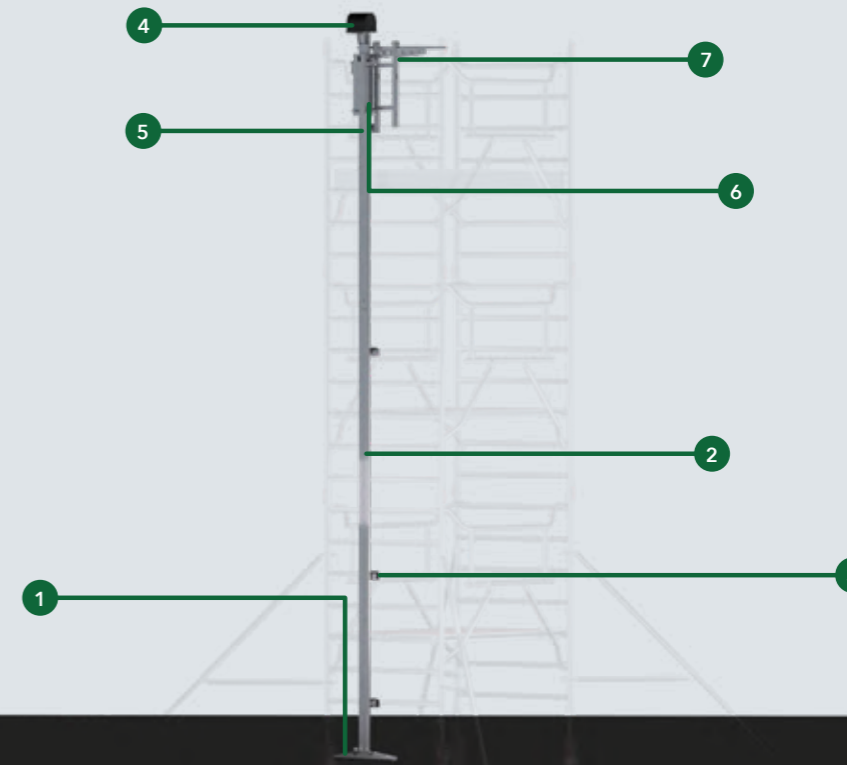

1	2	2	2*	3	4	5	6	7
2,66kg	3,46kg	5,58kg	**	0,52kg	9,20kg	0,60kg	4,64kg	16,18kg

(*) (**) Perfil inferior adicional ajustado, considerando as dimensões das rodas. (*) (**) Extra bottom profile adjusted considering the wheel dimensions.
(*) (**) Profil inférieur supplémentaire ajusté en tenant compte des dimensions des roues. (*) (**) Perfil inferior adicional ajustado considerando las dimensiones de las ruedas.

REF	1	2	3	4	5	6	7
5604620502019	201	1	1	2	1	1	1
5604620502026	202	1	1	3	1	1	1
5604620502033	203	1	2	3	1	1	1
5604620502040	204	1	2	4	1	1	1
5604620502057	205	1	3	4	1	1	1
5604620502064	206	1	3	5	1	1	1
5604620502071	207	1	4	5	1	1	1
5604620502088	208	1	4	6	1	1	1
5604620502095	209	1	5	6	1	1	1
5604620502101	210	1	5	7	1	1	1
5604620502118	211	1	6	7	1	1	1

ENERGY

Produto leve com grande resistência.

Lightweight but very strong product.

Produit léger à haute résistance.

Producto ligero con alta resistencia.



CLASSIK

Escadote em alumínio para utilização bricolage (DIY). Plataforma lacada sem superfícies cortantes, degraus estriados antiderrapantes com duplo rebite e arco de segurança. Cintas de segurança a partir de 5 degraus e pés antiderrapantes.

Aluminium stepladder for do-it-yourself (DIY). Non-slip powder coated platform free of sharp edges, double-rivet steps with non-slip ribbed surface and safety rail. Safety straps from 5 steps and slip-resistant feet.

Escabeau en aluminium pour utilisation bricolage (DIY). Plateforme laquée sans arêtes vives, marches à double rivet avec stries antidérapantes et garde-corps. Sangles de sécurité à partir du 5 marches et sabot emboitable antidérapant.

Escalera de aluminio para uso bricolaje (DIY). Plataforma lacada sin bordes afilados, peldaños estriados antideslizantes con doble remache y arco de seguridad. Cintas de seguridad a partir de 5 peldaños y tacos antideslizantes.



5604620010620	2	0,36m	2,36m	0,97m	0,38m	1,05m	0,12m	2,48kg
5604620010637	3	0,56m	2,56m	1,17m	0,40m	1,28m	0,12m	3,04kg
5604620010644	4	0,67m	2,67m	1,38m	0,43m	1,51m	0,12m	3,62kg
5604620010651	5	0,98m	2,98m	1,59m	0,45m	1,74m	0,12m	4,23kg
5604620010668	6	1,19m	3,19m	1,81m	0,48m	1,97m	0,12m	4,93kg
5604620010675	7	1,40m	3,40m	2,01m	0,50m	2,20m	0,13m	5,84kg
5604620010682	8	1,61m	3,61m	2,22m	0,52m	2,43m	0,13m	6,51kg

OPÇÃO
OPTION
OPTION
OPCIÓN



Escadote reforçado em alumínio. Degraus estriados antiderrapantes com largura de 120 mm e duplo rebite. Plataforma antiderrapante sem superfícies cortantes e arco de segurança. Cintas de segurança a partir de 5 degraus e pés antiderrapantes.

Aluminium heavy-duty stepladder. Deep tread steps (120 mm) with non-slip ribbed surface and double-rivet. Non-slip platform free of sharp edges and safety rail. Safety straps from 5 steps and slip-resistant feet.

larges (120 mm) à double rivet avec stries antidérapantes. Plateforme antidérapant sans arêtes vives et garde-corps. Sangles de sécurité à partir du 5 marches et sabot emboitable antidérapant.

Escalera de aluminio reforzada. Peldaños anchos (120 mm) estriados antideslizantes con doble remache. Plataforma antideslizante sin bordes afilados y arco de seguridad. Cintas de seguridad a partir de 5 peldaños y tacos antideslizantes.

Escabeau solide en aluminium. Marches



5604620010538	3	0,57m	2,57m	1,20m	0,41m	1,28m	0,14m	3,78kg
5604620010545	4	0,79m	2,79m	1,41m	0,45m	1,51m	0,14m	4,58kg
5604620010552	5	1,02m	3,02m	1,63m	0,48m	1,74m	0,14m	5,42kg
5604620010569	6	1,23m	3,23m	1,84m	0,50m	1,89m	0,14m	6,34kg
5604620010576	7	1,44m	3,44m	2,06m	0,53m	2,20m	0,14m	7,20kg
5604620010583	8	1,65m	3,65m	2,27m	0,59m	2,43m	0,14m	8,08kg

OPÇÃO
OPTION
OPTION
OPCIÓN

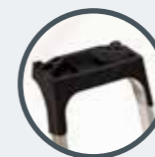

DUPLO

Escadote em alumínio de duplo acesso. Degraus estriados antiderrapantes com duplo rebite e dispositivo de segurança antiabertura. Cintas de segurança e pés antiderrapantes.

Aluminium double-sided stepladder. Double-rivet steps with non-slip ribbed surface and safety locking mechanism. Safety straps from 5 steps and slip-resistant feet.

Escabeau double accès en aluminium. Marches à double rivet avec stries antidérapantes et mécanisme de verrouillage de sécurité. Sangles de sécurité et sabot emboîtable antidérapant.

Escalera de aluminio de doble acceso. Peldaños estriados antideslizantes con doble remache y bloqueo de seguridad. Cintas de seguridad y tacos antideslizantes.



5604620022531	3	0,14m	2,14m	0,65m	0,41m	0,70m	0,16m	3,16kg
5604620022548	4	0,38m	2,38m	0,90m	0,44m	0,96m	0,16m	4,16kg
5604620022555	5	0,62m	2,62m	1,14m	0,46m	1,22m	0,16m	5,35kg
5604620022562	6	0,86m	2,86m	1,39m	0,49m	1,48m	0,16m	6,41kg
5604620022579	7	1,10m	3,10m	1,63m	0,51m	1,74m	0,16m	7,50kg
5604620022586	8	1,34m	3,34m	1,88m	0,54m	2,00m	0,16m	8,62kg



CONFORTO

Escadote extra-largo com arco de segurança. Plataformas alargadas antiderrapantes (265x385 mm), estabilidade reforçada e dispositivo de segurança antiabertura. Facilidade de transporte e arrumação.

Extra-large folding stepladder with safety rail. Large non-slip rubber steps (265x385 mm), increased stability and safety locking mechanism. Easy transport and storage.

Marchepied extra-large avec garde corps. Marches de grande dimension avec tapis antidérapants (265x385 mm), stabilité renforcée et mécanisme de verrouillage de sécurité. Transporte et stockage aisé.

Escalera extra-ancha con arco de seguridad. Peldaños anchos antideslizantes (265x385 mm), estabilidad reforzada y bloqueo de seguridad. Fácil almacenamiento y transporte.



5604620025129	2	0,47m	2,47m	0,87m	0,48m	0,95m	0,09m	4,70kg
5604620025136	3	0,72m	2,72m	1,12m	0,48m	1,22m	0,09m	6,50kg
5604620025143	4	0,97m	2,97m	1,37m	0,48m	1,49m	0,09m	8,50kg

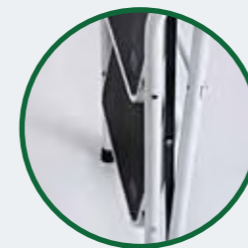

DELUX

Banco escadote em alumínio. Plataforma ampla (265x385 mm), degraus estriados antiderrapantes com duplo rebite e dispositivo de segurança antiabertura. Cintas de segurança e pés antiderrapantes. Facilidade de transporte e arrumação.

Aluminium step stool. Large standing platform (265x385 mm), double-rivet steps with non-slip ribbed surface and safety locking mechanism. Safety straps and slip-resistant feet. Easy transport and storage.

Tabouret en aluminium. Large plateforme (265x385 mm), marches à double rivet avec stries antidérapantes et mécanisme de verrouillage de sécurité. Sangles de sécurité et sabot emboîtable antidérapant. Transporte et stockage aisé.

Taburete plegable ligero de aluminio. Plataforma ancha (265x385 mm), peldaños estriados antideslizantes con doble remache y bloqueo de seguridad. Cintas de seguridad y tacos antideslizantes. Fácil almacenamiento y transporte.



5604620002922	2	0,36m	2,36m	0,42m	0,53m	0,17m	2,20kg
5604620002939	3	0,60m	2,60m	0,44m	0,78m	0,17m	2,83kg



ARTICULADA

Escada articulada telescópica em alumínio. Utilizável em 3 posições diferentes: escada extensível, posição de escadote e em superfícies desniveladas. Degrau antiderrapante confortável (30x30 mm) e largura interior da escada com 285 mm. Articulações Multiusos sistema de bloqueio da parte deslizante e tacos antiderrapantes. Base alargada para maior estabilidade.

Aluminium multi-purpose telescopic ladder. Ladder can be used in 3 different positions: extension ladder position, standing position and working on uneven ground. Comfortable non-slip rung (30x30 mm) and inner width of the ladder 285 mm. Multiusos hinges, sliding mechanism with locks and slip-resistant feet. Wider base to improve stability.

Échelle pliante télescopique en aluminium. Utilisable en 3 positions différentes: échelle simple, autostable et en dénivelés. Échelons antidérapant confortable de (30x30 mm) et largeur intérieure de l'échelle de 285 mm. Articulation Multiusos, système de blocage du plan coulissant et sabots antidérapants. Base évasée pour une meilleure stabilité.

Escalera telescópica multifunción profesional de aluminio. La escalera se puede cambiar en 3 posiciones diferentes: extensible, tijera y para trabajo en desnivel. Cómodo peldaño antideslizante de (30x30 mm) y ancho interior de la escalera de 285 mm. Bisagras Multiusos, sistema de posicionamiento con agarre y patas antideslizantes. Base ancha para alta estabilidad.

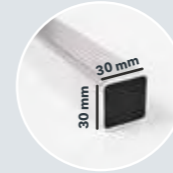

5604620001239	3+3	0,92m	2,87m	2,77m	3,96m	1,49m	1,44m	2,63m	0,51m	0,21m	8,88kg
5604620001246	4+4	1,48m	3,43m	3,31m	4,50m	1,72m	1,66m	2,85m	0,51m	0,21m	11,50kg



MULTIUSOS

Escada multifunções em alumínio com plataforma. Utilizável em 3 posições diferentes: escada extensível, posição de escadote e bancada de trabalho (1400x290 mm). Degrau antiderrapante confortável (30x30 mm) e largura interior da escada com 285 mm. Articulações Multiusos e estabilizador antiderrapante.

Aluminium multi-purpose ladder with platform. Ladder can be used in 3 different positions: extension ladder position, standing position and work platform (1400x290 mm). Comfortable non-slip rung (30x30 mm) and inner width of the ladder 285 mm. Multiusos hinges and slip-resistant cross-beam.

Échelle multi positions en aluminium avec plateforme. Utilisable en 3 positions différentes: échelle simple, autostable et plateforme de travail (1400x290 mm). Échelons antidérapant confortable de (30x30 mm) et largeur intérieure de l'échelle de 285 mm. Articulation Multiusos et embase stabilisatrice antidérapant.

Escalera multifuncional de aluminio con plataforma. La escalera se puede cambiar en 3 posiciones: extensible, tijera y plataforma de trabajo (1400x290 mm). Cómodo peldaño antideslizante de (30x30 mm) y ancho interior de la escalera de 285 mm Bisagras Multiusos y patas antideslizantes.



5604620021503 4x3 0,94m 3,47m 3,35m 4,54m 1,75m 1,69m 2,87m 0,93m 2,93m 0,33m 0,25m 15,05kg

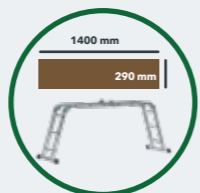

Escada multifunções em alumínio com plataforma. Utilizável em 3 posições diferentes: escada extensível, posição de escadote e bancada de trabalho (1400x290 mm). Degrau antiderrapante confortável (30x30 mm) e largura interior da escada com 285 mm. Articulações Multiusos e estabilizador antiderrapante.

Aluminium multi-purpose ladder with platform. Ladder can be used in 3 different positions: extension ladder position, standing position and work platform (1400x290 mm). Comfortable non-slip rung (30x30 mm) and inner width of the ladder 285 mm. Multiusos hinges and slip-resistant cross-beam.

Échelle multi positions en aluminium avec plateforme. Utilisable en 3 positions différentes: échelle simple, autostable et plateforme de travail (1400x290 mm). Échelons antidérapant confortable de (30x30 mm) et largeur intérieure de l'échelle de 285 mm. Articulation Multiusos et embase stabilisatrice antidérapant.

Escalera multifuncional de aluminio con plataforma. La escalera se puede cambiar en 3 posiciones: extensible, tijera y plataforma de trabajo (1400x290 mm). Cómodo peldaño antideslizante de (30x30 mm) y ancho interior de la escalera de 285 mm Bisagras Multiusos y patas antideslizantes.



5604620125065	6	1,76m	1,70m	2,89m	0,34m	52mm	2,70kg
5604620125072	7	2,04m	1,97m	3,16m	0,34m	52mm	3,10kg
5604620125089	8	2,32m	2,25m	3,43m	0,34m	52mm	3,49kg
5604620125096	9	2,60m	2,52m	3,70m	0,34m	52mm	3,89kg
5604620125102	10	2,88m	2,79m	3,97m	0,34m	52mm	4,29kg
5604620125126	12	3,44m	3,33m	4,52m	0,34m	52mm	5,97kg
5604620125140	14	4,00m	3,87m	5,06m	0,34m	52mm	6,81kg



TREK X2

Escada transformável de 2 lances em alumínio. Mecanismo de fácil utilização para transformar a escada em posição de escadote. Degrau antiderrapante confortável (25x25 mm) e largura interior da escada com 290 mm. Estabilizador antiderrapante e cintas de segurança.

Aluminium 2 section combination ladder. Easy-to-use mechanism to transform the ladder in standing position. Comfortable non-slip rung (25x25 mm) and inner width of the ladder 290 mm. Slip-resistant cross-beam and safety straps.

Échelle transformable 2 plans en aluminium. Articulation facile à utiliser pour transformer l'échelle en position autostable. Échelons antidérapant confortable de (25x25 mm) et largeur intérieure de l'échelle de 290 mm. Embase stabilisatrice antidérapant et sangles de sécurité.

Escalera industrial de aluminio de 2 tramos. Dispositivo fácil de utilizar para transformar la escalera en posición de tijera. Cómodo peldaño antideslizante de (25x25 mm) y ancho interior de la escalera de 290 mm. Base estabilizadora antideslizante y cintas de seguridad.



5604620225062	2x6	1,76m	2,88m	2,79m	3,97m	1,76m	1,70m	2,89m	0,40m	110mm	6,62kg
5604620225079	2x7	2,04m	3,16m	3,06m	4,25m	2,04m	1,97m	3,16m	0,40m	110mm	7,44kg
5604620225086	2x8	2,32m	3,44m	3,33m	4,52m	2,32m	2,25m	3,43m	0,40m	110mm	8,31kg
5604620225093	2x9	2,60m	4,00m	3,87m	5,06m	2,60m	2,52m	3,70m	0,40m	115mm	9,36kg
5604620225109	2x10	2,88m	4,56m	4,41m	5,60m	2,88m	2,79m	3,97m	0,40m	120mm	10,67kg
5604620225123	2x12	3,44m	5,68m	5,49m	6,68m	3,44m	3,33m	4,52m	0,40m	130mm	13,21kg

OPÇÃO
OPTION
OPTION
OPCIÓN



TREK X3

Escada transformável de 3 lances em alumínio. Degrau antiderrapante confortável (25x25 mm) e largura interior da escada com 290 mm. Mecanismo de fácil utilização para transformar a escada em posição de escadote. Estabilizador antiderrapante e cintas de segurança.

Aluminium 3 section combination ladder. Easy-to-use mechanism to transform the ladder in standing position. Comfortable non-slip rung (25x25 mm) and inner width of the ladder 290 mm. Slip-resistant cross-beam and safety straps.

Échelle transformable 3 plans en aluminium. Articulation facile à utiliser pour transformer l'échelle en position autostable. Échelons antidérapant confortable de (25x25 mm) et largeur intérieure de l'échelle de 290 mm. Embase stabilisatrice antidérapant et sangles de sécurité.

Escalera industrial transformable de aluminio de 3 tramos. Dispositivo fácil de utilizar para transformar la escalera en posición de tijera. Cómodo peldaño antideslizante de (25x25 mm) y ancho interior de la escalera de 290 mm. Base estabilizadora antideslizante y cintas de seguridad.



5604620325069	3x6	1,76m	3,16m	3,06m	4,25m	2,60m	2,52m	3,70m	0,47m	140mm	10,23kg
5604620325076	3x7	2,04m	4,00m	3,87m	5,06m	3,16m	3,06m	4,25m	0,47m	145mm	11,75kg
5604620325083	3x8	2,32m	4,56m	4,41m	5,60m	3,72m	3,72m	4,79m	0,47m	145mm	13,06kg
5604620325090	3x9	2,60m	5,40m	5,22m	6,41m	4,28m	4,28m	5,33m	0,47m	155mm	15,00kg
5604620325106	3x10	2,88m	6,52m	6,30m	7,49m	4,84m	4,84m	5,87m	0,47m	180mm	17,80kg

OPÇÃO
OPTION
OPTION
OPCIÓN



COMBY



5min.



Échafaudage multi positions en aluminium pour une utilisation bricolage. Utilisable en 3 positions différentes: échafaudage, échelle simple et position autostable. Dimension plateforme (avec trappe) 1200x440 mm et roues pour un transport facile. Montage rapide et sans outil.

Andamio multifuncional de aluminio para bricolaje. Combi se puede cambiar en 3 posiciones: andamio, escalera extensible y tijera. Dimension plataforma (con trampilla) 1200x440 mm y ruedas para cómodo posicionamiento. Fácil montaje (sin necesidad de herramientas).

Andaime multifunções bricolage em alumínio. Utilizável em 3 posições diferentes: andaime, escada extensível e posição de escadote. Dimensão da plataforma (com alçapão) 1200x440 mm e equipado com rodas para facilitar o posicionamento. Montagem facilitada sem ferramentas.

DIY multi-purpose aluminium scaffold. Combi can be used in 3 different positions: scaffolding, extension ladder position and standing position. Platform (with hatch) dimension 1200x440 mm and equipped with wheels for easy positioning. Easy to assemble - no tools needed.



5604620111105	10+10	1,88m	4,00m	2,84m	1,34m	0,53m	148x52x33cm	26,76kg

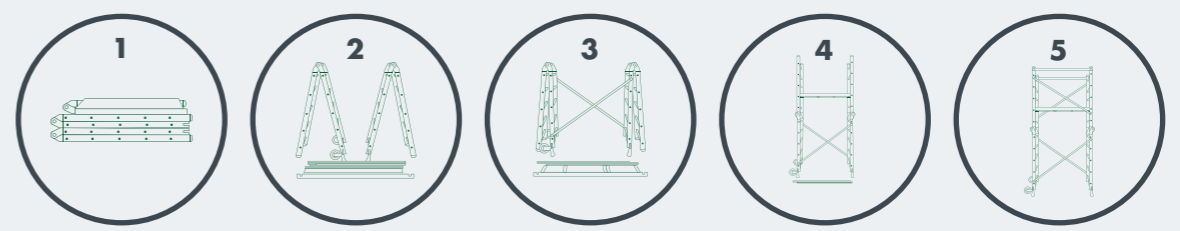

HANDY



2min.



Andaime bricolage em alumínio. Solução versátil com 3 alturas de trabalho, dimensão da plataforma 1100x400 mm e equipado com rodas para facilitar o posicionamento. Montagem facilitada sem ferramentas.

DIY aluminium scaffold. Versatile solution with 3 working heights, platform dimension 1100x400 mm and equipped with wheels for easy positioning. Easy to assemble - no tools needed.

Échafaudage en aluminium pour une utilisation bricolage. Polyvalent avec 3 hauteurs de travail, dimension plateforme 1100x400 mm et roues pour un transport facile. Montage rapide et sans outil.

Andamio de aluminio para bricolaje. Versátil con 3 alturas de trabajo, dimensión plataforma 1100x400 mm y ruedas para cómodo posicionamiento. Fácil montaje (sin necesidad de herramientas).



5604620111105	5+5	0,88m	3,00m	1,58m	1,14m	0,47m	170x53x16cm	11,73kg

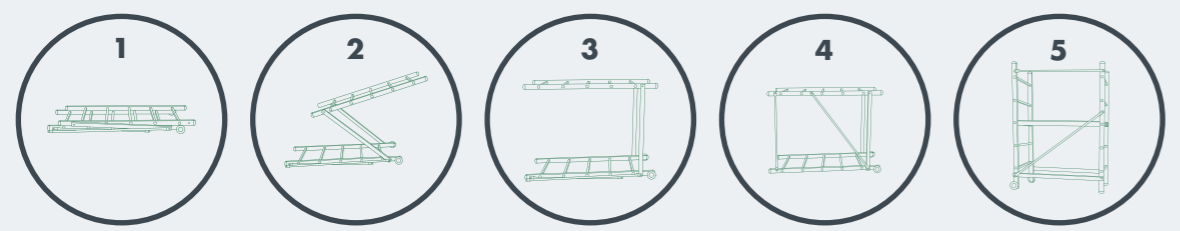

Andaime modular em alumínio. Dimensão da plataforma (com alçapão) 1200x450 mm e equipado com rodas para facilitar o posicionamento. Estabilizadores incluídos a partir do pack B. Montagem facilitada sem ferramentas.

Modular aluminium scaffold. Platform (with hatch) dimension 1200x450 mm and equipped with wheels for easy positioning. Stabilizers included from pack B. Easy to assemble - no tools needed.

Échafaudage roulant en aluminium. Dimension plateforme (avec trappe) 1200x450 mm et roues pour un transport facile. Stabilisateurs inclus dans le pack B. Montage rapide et sans outil.

Andamio modular de aluminio. Dimensión plataforma (con trampilla) 1200x450 mm y ruedas para cómodo posicionamiento. Estabilizadores incluidos a partir del pack B. Fácil montaje (sin necesidad de herramientas).

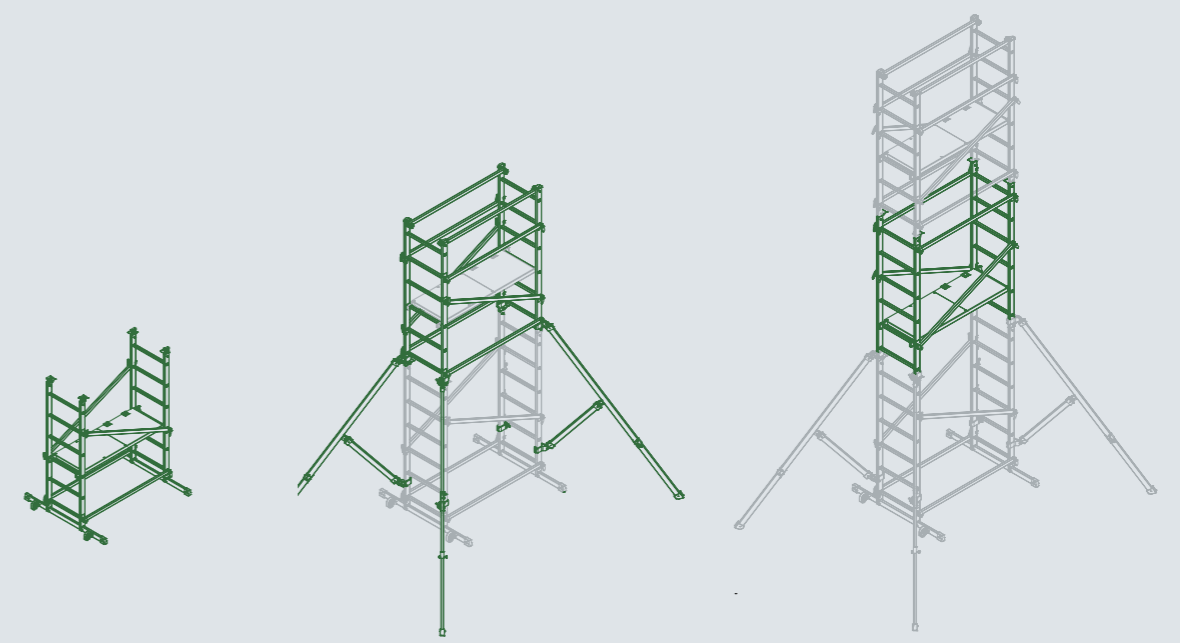

PACK - A

PACK - A+B

PACK - A+B+C

PACKS		H	H	H	H	H	KG
-------	--	---	---	---	---	---	----

A	5604620040511	0,77m	2,27m	1,70m	1,34m	0,51m	17,79kg
A+B	5604620040528	2,45m	4,45m	3,38m	1,34m	0,51m	43,12kg
A+B+C	5604620040535	4,13m	6,13m	5,06m	1,34m	0,51m	58,14kg



VOLT

A melhor escolha para trabalhos elétricos.

Best choice for electrical work.

Le meilleur choix pour les travaux électriques.

La mejor alternativa para trabajos eléctricos.



ELECTRA

Escadote profissional em fibra de vidro com arco de segurança. Plataforma ampla 330x257 mm e degraus estriados antiderrapantes. Porta ferramentas, cintas de segurança e pés antiderrapantes.

Professional fiberglass stepladder with safety rail. Large non-slip platform 330x257 mm and ribbed steps. Tool holder, safety straps and slip-resistant feet.

Escabeau professionnel en fibre de verre avec garde corps. Large plateforme 330x257 mm et marches striées antidérapants. Porte-outils, sangles de sécurité et sabot emboitable antidérapant.

Escalera profesional de fibra de vidrio con arco de seguridad. Plataforma ancha 330x257 mm y peldaños estriados antideslizantes. Bandeja porta-herramientas, cintas de seguridad y patas antideslizantes.



Barcode	Steps	Height	Width	Depth	Platform Length	Platform Width	Platform Depth	Weight
---------	-------	--------	-------	-------	-----------------	----------------	----------------	--------

5604620160240	4	0,71m	2,71m	1,34m	0,44m	1,74m	0,15m	6,77kg
5604620160257	5	0,94m	2,94m	1,58m	0,45m	2,00m	0,15m	9,97kg
5604620160264	6	1,18m	3,18m	1,81m	0,46m	2,26m	0,15m	11,37kg
5604620160271	7	1,41m	3,41m	2,05m	0,47m	2,52m	0,15m	12,77kg

ELECTRA SINGLE

Escadote profissional em fibra de vidro. Degraus estriados antiderrapantes. Porta ferramentas, cintas de segurança e pés antiderrapantes.

Professional fiberglass stepladder. Non-slip ribbed steps. Tool holder, safety straps and slip-resistant feet.

Escabeau professionnel en fibre de verre. Marches striées antidérapants. Porte-outils, sangles de sécurité et sabot emboitable antidérapant.

Escalera profesional de fibra de vidrio. Peldaños estriados antideslizantes. Bandeja porta-herramientas, cintas de seguridad y patas antideslizantes.



Barcode	Steps	Height	Width	Depth	Platform Length	Platform Width	Platform Depth	Weight
---------	-------	--------	-------	-------	-----------------	----------------	----------------	--------

5604620160134	3	0,61m	2,61m	0,91m	0,42m	1,08m	0,15m	7,37kg
5604620160158	5	1,09m	3,09m	1,39m	0,45m	1,58m	0,15m	9,37kg
5604620160172	7	1,57m	3,57m	1,87m	0,48m	2,08m	0,15m	11,57kg
5604620160196	9	2,05m	4,05m	2,35m	0,51m	2,58m	0,15m	13,77kg

ELECTRA PROTECT

Plataforma profissional de trabalho portátil em fibra de vidro com guarda-corpos de segurança. Proteção traseira e porta ferramentas. Degraus estriados antiderrapantes e plataforma alargada (470x403 mm) para reforçar o conforto e a resistência do produto. Facilidade de transporte e arrumação.

Fiberglass professional mobile working platform with safety guardrails. Fall protection safety gates and toolholder. Non-slip ribbed steps and large platform (470x403 mm) to improve comfort and increase performance of the product. Easy transport and storage.

Plateforme Individuelle Roulante Légère (PIRL) professionnelle en fibre de verre avec garde-corps. Portillon de sécurité et porte-outils. Construction robuste avec marches striées antidérapants et plateforme de grande dimension (470x403 mm) pour améliorer le confort. Facile à transporter et à stocker.

Plataforma de trabajo móvil profesional de fibra de vidrio con barandillas de seguridad. Protección trasera y bandeja porta-herramientas. Peldaños estriados antideslizantes y plataforma ancha (470x403 mm) para máxima comodidad y reforzar al máximo la resistencia del producto. Fácil almacenamiento y transporte.



Barcode	Steps	Platform Width	Platform Depth	Platform Height	Step Height	Step Depth	Step Width	Weight
5604620160332	3	0,86m	2,86m	1,76m	0,59m	1,95m	0,23m	14,07kg
5604620160349	4	1,14m	3,14m	2,04m	0,61m	2,21m	0,23m	16,87kg
5604620160356	5	1,43m	3,43m	2,33m	0,62m	2,47m	0,23m	18,37kg
5604620160363	6	1,71m	3,71m	2,61m	0,65m	2,83m	0,23m	20,87kg

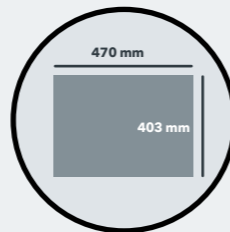

ELECTRA X3

Escada profissional transformável de 3 lances em alumínio e fibra de vidro. Mecanismo de fácil utilização para transformar a escada em posição de escadote. Degrau antiderrapante confortável (30x30 mm) e largura interior da escada com 300 mm. Estabilizador antiderrapante e cintas de segurança.

Professional aluminium and fiberglass 3 section combination ladder. Easy-to-use mechanism to transform the ladder in standing position. Comfortable non-slip rung (30x30 mm) and inner width of the ladder 300 mm. Slip-resistant cross-beam and safety straps.

Échelle professionnelle transformable 3 plans en aluminium et fibre de verre. Articulation facile à utiliser pour transformer l'échelle en position autostable. Échelons antidérapant confortable de (30x30 mm) et largeur intérieure de l'échelle de 300 mm. Embase stabilisatrice antidérapant et sangles de sécurité.

Escalera profesional industrial de aluminio y fibra de vidrio de 3 tramos. Dispositivo fácil de utilizar para transformar la escalera en posición de tijera. Cómodo peldaño antideslizante de (30x30 mm) y ancho interior de la escalera de 300 mm. Base estabilizadora antideslizante y cintas de seguridad.

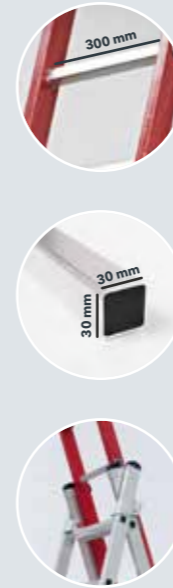

Barcode	Sections	Step Width	Step Depth	Step Height	Step Depth	Step Width	Step Depth	Step Width	Step Depth	Step Height	Step Depth	Step Width	Step Depth	Weight
5604620073106	3x10	2,88m	6,24m	6,03m	7,22m	4,84m	4,68m	5,87m	0,48m	0,18m	20,97kg			

OPÇÃO
OPTION
OPCIÓN

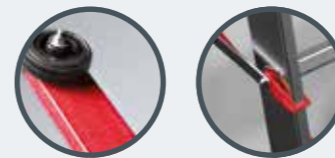

ELECTRA CORDA X3

Escada profissional de 3 lances extensível com corda em alumínio e fibra de vidro. Mecanismo de corda para facilitar a abertura da escada sem articulações laterais, prevenindo lesões na utilização do produto. Degrau antiderrapante confortável (30x30 mm) e largura interior da escada com 300 mm. Estabilizador de segurança antiderrapante.

Aluminium and fiberglass professional 3 section extension ladder - rope operated. Rope mechanism to facilitate the opening of the ladder without side hinges, preventing injuries when using the product. Comfortable non-slip rung (30x30 mm) and inner width of the ladder 300 mm. Slip-resistant safety cross-beam.

Échelle professionnelle coulissante à corde 3 plans en aluminium et fibre de verre. Mécanisme à corde pour faciliter l'ouverture de l'échelle sans articulations latérales, évitant les blessures lors de l'utilisation du produit. Echelons antidérapant confortable de (30x30 mm) et largeur intérieure de l'échelle de 300 mm. Embase stabilisatrice antidérapant pour plus de sécurité.

Escalera profesional extensible 3 tramos con cuerda de aluminio y fibra de vidrio. Mecanismo de cuerda para facilitar la apertura de la escalera sin bisagras laterales, evitando lesiones al utilizar el producto. Cómodo peldaño antideslizante de (30x30 mm) y ancho interior de la escalera de 300 mm. Base estabilizadora antideslizante de seguridad.

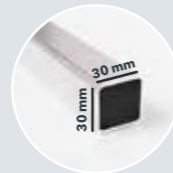

5604620113109



3x10



2,88m



6,24m



6,03m



7,22m



0,48m



0,18m



23,06kg

OPÇÃO
OPTION
OPTION
OPCIÓN



Escadas em fibra sob pedido.
Fiberglass ladders available upon request.
Échelles en fibre sur demande.
Escaleras de fibra bajo pedido.

PARTS

Todas as peças substituíveis dos seus equipamentos FERRAL, num único lugar.

All the replaceable parts for your FERRAL equipment, in one place.

Toutes les pièces remplaçables de vos équipements FERRAL, en un seul endroit.

Todas las piezas sustituibles de tus equipos FERRAL, en un solo lugar.

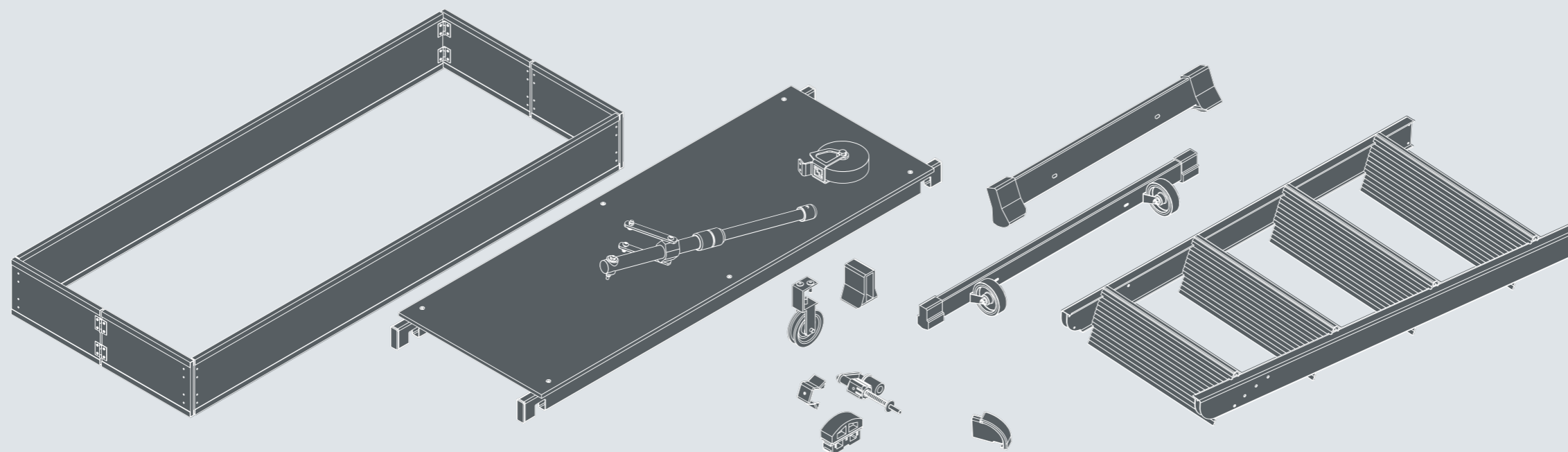

Ferral - José Luís & Ca. Lda

Rua dos Sobrais, 655
Zona Industrial Sul - Apartado 70
3885-307 Cortegaça, Portugal

T. +351 256 790 800
E. ferraljl@ferraljl.com



www.ferraljl.com



Design: Hugo Maia www.hugomaia.projects.myportfolio.com

